

Structural Calculations for:

Yang Residence REV03

Project Address:
7431 E Mercer Way
Mercer Island, WA 98040

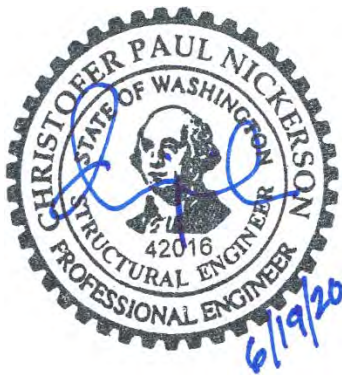



Structural Engineering by:

Nickerson Engineering

2221 Everett Ave, #202
Everett, WA 98201

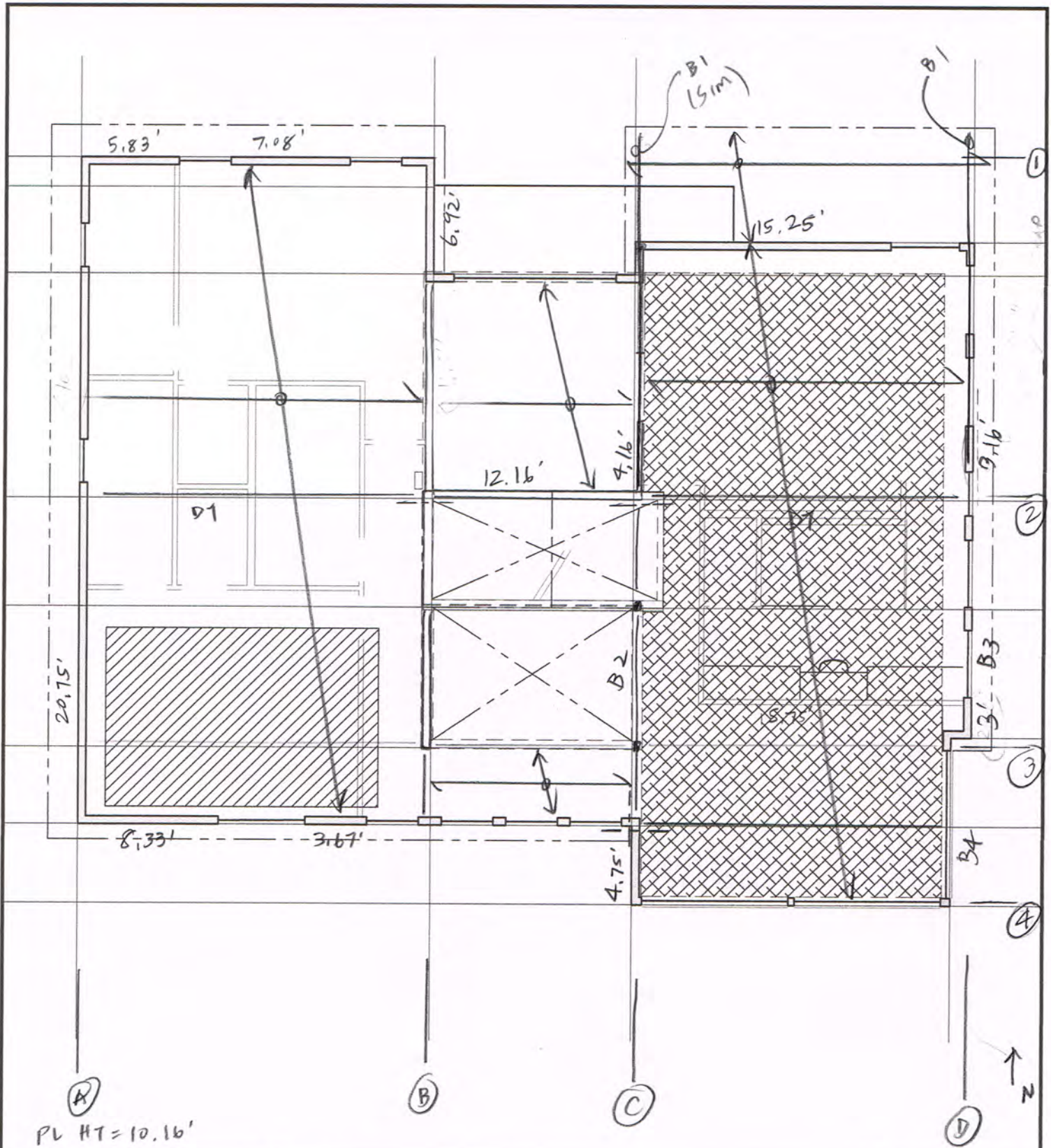
Design per:
2015 International Building Code



 <p>nickerson engineering</p> <p>2221 Everett Ave #202 Everett, WA 98201 425.610.4425</p>	Description	ROOF FRAMING PLAN	Sheet <h1>KP1</h1> Scale: 1/8" = 1'-0"
	Project	YANG RESIDENCE	
	Job No.	19-065	
	Date		

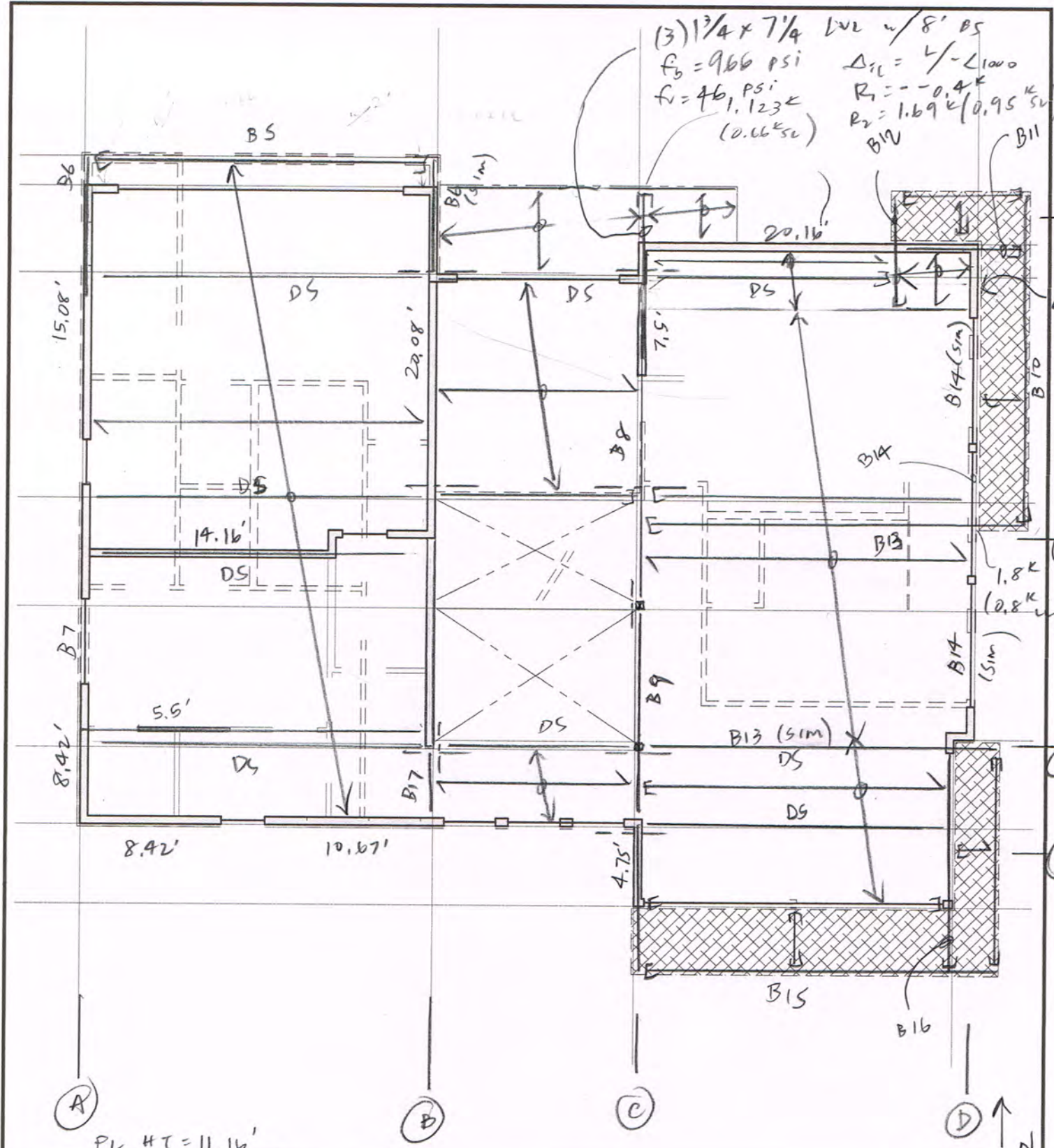

nickerson engineering
 2221 Everett Ave #202
 Everett, WA 98201
 425.610.4425

Description	UPPER FLOOR FRAMING PLAN
Project	YANG RESIDENCE
Job No.	19-065
Date	

Sheet
KP2
 Scale: 1/8" = 1'-0"

DESIGN CRITERIA

CODE : 2015 IBC

SNOW LOAD : 25 PSF

LIVE LOAD : 40 PSF (60 PSF @ DECKS)

ROOF DL : 15 PSF

DECK DL : 15 PSF

FLOOR DL : 12 PSF

ALLOWABLE SOIL BEARING : 2000 PSF (PER GEOTECH REPORT)

1/2" GYPCRETE : 13 PSF
(@ UPPER FLOOR)

BY CASCADE GEOTECH NW
DATED 12/5/18

ROOF FRAMING

B1

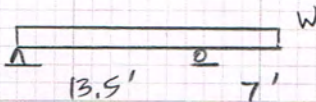

D+L: UNBAL. SPAN WORST CASE

$$W = 75 \left(\frac{20}{2} + 1.16 \right) = 837 \text{ PLF (670 PLF LL)}$$

$$f_b = 1133 \text{ psi}$$

$$f_v = 132 \text{ psi}$$

$$\Delta_{TV} = \frac{L}{K-1000}$$

5/4 x 16 PSL

$$R_1 = 4.26 \text{ K (3.31 K LL)}$$

$$R_2 = 13.44 \text{ K (10.42 K LL)}$$

$$(R_1 = -0.262 \text{ K UNBAL. SPAN})$$

B2 D+L:

$$l = 9'$$

$$W = 75 \left(\frac{20}{2} \right) = 750 \text{ PLF (600 PLF LL)}$$

$$f_b = 1686 \text{ psi}$$

$$f_v = 124 \text{ psi}$$

$$\Delta_{TV} = \frac{L}{681}$$

3 1/2 x 11 7/8 LSL

$$R = 3.424 \text{ K}$$

$$(2.7 \text{ K LL})$$

B3 D+L

$$l = 4.5'$$

$$W = 837 \text{ PLF (670 PLF LL)}$$

$$f_b = 835 \text{ psi} < \frac{1300}{\text{psi}} \quad 4 \times 8$$

$$f_v = 112 \text{ psi}$$

$$\Delta_{TV} = \frac{L}{71000}$$

$$R = 1.90 \text{ K}$$

$$(1.51 \text{ K LL})$$

B4 D+L

$$l = 9.5'$$

$$W = 75 \left(\frac{19}{2} \right) = 713 \text{ PLF (570 PLF LL)}$$

$$f_b = 1173 \text{ psi} \quad 3 \frac{1}{2} \times 11 \frac{7}{8} \text{ LSL}$$

$$f_v = 97 \text{ psi}$$

$$\Delta_{TV} = \frac{L}{682}$$

$$R = 3.44 \text{ K}$$

$$(2.71 \text{ K LL})$$

PROJECT

YANG RES.

DATE

6/27/19

PROJ. NO.

19-065

DESIGN

CKS

SHEET

61

UPPER FLOOR FRAMING

B5 D+L:

$$l = 20.08'$$

$$W = 15(3) + 102 + 65(1.33) = 233 \text{ PLF} \quad (53.2 \text{ PLF LL})$$

$$f_b = 1238 \text{ psi}$$

$$f_v = 61 \text{ psi} \quad 5\frac{1}{4} \times 11\frac{7}{8} \text{ PSL}$$

$$\Delta_{TL} = L/275 \quad R = 2.54 \text{ K} \quad (0.534 \text{ K LL})$$

D+S:

$$W = 40(3) + 102 + 15(1.33) = 242 \text{ PLF} \quad (75 \text{ PLF SL})$$

$$f_b = 1282 \text{ psi}$$

$$f_v = 63 \text{ psi} \quad 5\frac{1}{4} \times 11\frac{7}{8} \text{ PSL}$$

$$\Delta_{TL} = L/273 \quad R = 2.63 \text{ K} \quad (0.753 \text{ K SL})$$

B6

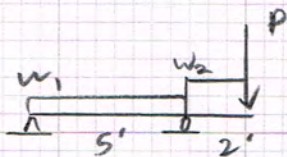

D+L:

$$W_1 = 25(20/2) = 250 \text{ PLF DL}$$

$$W_2 = 65(20/2) + 102 + 15(2\frac{1}{2} + 2)$$

$$W_2 = 940 \text{ PLF} \quad (400 \text{ PLF LL})$$

$$P = 1.47 \text{ K DL}$$

$$f_b = 473 \text{ psi} \quad 5\frac{1}{4} \times 11\frac{7}{8} \text{ PSL}$$

$$f_v = 82 \text{ psi} \quad R_1 = -0.3 \text{ K}$$

$$\Delta_{TL} = L/1000 \quad R_2 = 5.034 \text{ K} \quad (0.96 \text{ K LL})$$

B6 CONT...

D+0.75(S+L)

$$W_1 = 25(20/2) = 250 \text{ PLF DL}$$

$$W_2 = 55(20/2) + 102 + 33.75(12.5)$$

$$W_2 = 1074 \text{ PLF} \quad (534 \text{ PLF LL})$$

$$P = 1.358 \text{ K} \quad (0.563 \text{ K LL})$$

$$f_b = 477 \text{ psi} \quad 5\frac{1}{4} \times 11\frac{7}{8} \text{ PSL}$$

$$f_v = 85 \text{ psi}$$

$$\Delta_{TL} = L/1000 \quad R_1 = -0.31 \text{ K}$$

$$R_2 = 5.2 \text{ K}$$

B7

D+0.75(S+L):

$$l = 6'$$

$$W = 33.75(12.5) + 102 + 55(2\frac{1}{2})$$

$$W = 1101.4 \text{ PLF} \quad (549.4 \text{ PLF LL})$$

$$f_b = 1418 \text{ psi} \quad 3\frac{1}{2} \times 9 \text{ GLB}$$

$$f_v = 177 \text{ psi} \quad R = 3.342 \text{ K}$$

$$\Delta_{TL} = L/1000 \quad (1.65 \text{ K LL})$$

PROJECT

YANG RESI

DATE

6/27/19

PROJ. NO.

19-065

DESIGN

CKS

SHEET

62

UPPER FLOOR FRMG CONT...

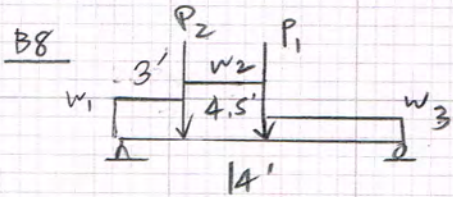

D+L - GOVERNS

$$W_1 = 65(32.5/2) = 1056.3 \text{ PLF } (650 \text{ PLF LL})$$

$$W_2 = 75(32.5/2) + 10(10.16 + 4) + 65(32.5/2)$$

$$W_2 = 2417 \text{ PLF } (1625 \text{ PLF LL})$$

$$W_3 = 65(20/2) = 650 \text{ PLF } (400 \text{ PLF LL})$$

$$P_1 = [15(7/2) + 10(10.16 + 4)](12.5/2) + 75(20/2)(7/2) = 3.84 \text{ K } (2.1 \text{ K LL})$$

$$P_2 = 75(32.5/2)(4.5/2) = 2.74 \text{ K } (2.194 \text{ K LL})$$

W10X26 $b = 8" \quad d = 10\frac{3}{8}"$

$$R_1 = 14.73 \text{ K } (9.614 \text{ K LL})$$

$$R_2 = 10.5 \text{ K } (6.543 \text{ K LL})$$

SEE B8 (D+L) OUTPUT ON PG 64

D+W

$$W_1 = 406.3 \text{ PLF DL}$$

$$W_2 = 792 \text{ PLF DL}$$

$$W_3 = 250 \text{ PLF DL}$$

$$P_1 = 1.74 \text{ K DL} + 2.43 \text{ K (W)} = 4.17 \text{ K}$$

$$P_2 = 0.546 \text{ K DL}$$

$$W10 \times 26 \quad R_1 = 6.24 \text{ K } (1.128 \text{ K W})$$

$$R_2 = 6.29 \text{ K } (1.3 \text{ K W})$$

SEE B8 (D+W) OUTPUT ON PG 65

PROJECT

YANG RES.

B8 CONT...

1.15D + 0.6E - OVERSTRENGTH f_b check only

$$W_1 = 467 \text{ PLF}$$

$$W_2 = 911 \text{ PLF}$$

$$W_3 = 288 \text{ PLF}$$

$$P_1 = 2.0 \text{ K} + 2.5(2.773) = 8.93 \text{ K}$$

$$P_2 = 0.63 \text{ K}$$

W10X26

SEE B8 (OVERSTRENGTH)

OUTPUT ON PG 66

B9 D+L

$$l = 9'$$

$$W = 65(20/2) = 650 \text{ PLF } (400 \text{ PLF LL})$$

$$f_b = 659 \text{ PSI } 5\frac{1}{4} \times 1\frac{7}{8} \text{ PS2}$$

$$f_v = 72.5 \text{ PSI } R = 3.013 \text{ K}$$

$$\Delta_{TL} = L/71000 \quad (1.8 \text{ K LL})$$

B10

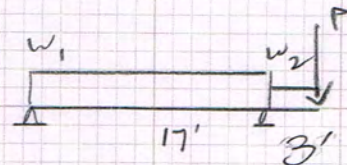

D+L

$$W_1 = 75(3/2) + 40 = 153 \text{ PLF } (90 \text{ PLF LL})$$

$$W_2 = 40 \text{ PLF DL}$$

$$P = 75(3/2)(8/2) = 0.45 \text{ K } (0.36 \text{ K LL})$$

$$f_b = 865 \text{ PSI}$$

$$f_v = 49 \text{ PSI}$$

5 1/2 x 9 GLB

$$\Delta_{TL} = L/372$$

$$R_1 = 1.29 \text{ K } (0.691 \text{ K LL})$$

$$R_2 = 2.14 \text{ K } (1.2 \text{ K LL})$$

DATE 6/27/19

PROJ. NO. 19-065

DESIGN CKS

SHEET 63

Yang Residence

Upper Floor Framing Plan

B8 (D+L)

Date: 6/28/19

Selection

W 10x 26 50 ksi Wide Flange Steel

Lateral Support: Lc = 5.2 ft max.

Conditions

Actual Size is 5-3/4 x 10-3/8 in.

Min Bearing Length R1= 0.9 in. R2= 0.9 in. (1.0) DL Defl= 0.17 in Recom Camber= 0.25 in

Data

Beam Span	14.0 ft	Reaction 1 LL	9614 #	Reaction 2 LL	6543 #
Beam Wt per ft	26.0 #	Reaction 1 TL	14726 #	Reaction 2 TL	10489 #
Bm Wt Included	364 #	Maximum V	14726 #		
Max Moment	54939 #	Max V (Reduced)	N/A		
TL Max Defl	L / 240	TL Actual Defl	L / 365		
LL Max Defl	L / 480	LL Actual Defl	L / 569		

Attributes

	Section (in ³)	Shear (in ²)	TL Defl (in)	LL Defl
Actual	27.90	2.69	0.46	0.30
Critical	19.98	0.74	0.70	0.35
Status	OK	OK	OK	OK
Ratio	72%	27%	66%	84%

Values

	Fb (psi)	Fv (psi)	E (psi x mil)
Ref. Value Fy	50000	50000	29.0
Adjusted Values	33000	20000	29.0

Adjustments

YP Factor, Lc	0.66	0.40
At Point Loads: Provide these minimum bearing lengths in inches or provide web stiffeners. B = 0.9 C = 0.9		

Loads

Point LL	Point TL	Distance	Par Unif LL	Par Unif TL	Start	End
2100	B = 3840	7.5	650	H = 1056	0	3.0
2194	C = 2740	3.0	1625	I = 2417	3.0	7.5
			400	J = 650	7.5	14.0

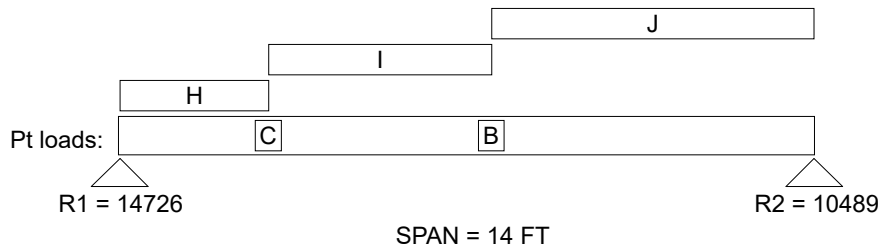

Uniform and partial uniform loads are lbs per lineal ft.

G5

BeamChek v2018 licensed to: Nickerson Engineering, LLC Reg # 6181-66005

Yang Residence

Upper Floor Framing Plan

B8 (D+W)

Date: 6/28/19

Selection

W 10x 26 50 ksi Wide Flange Steel

Lateral Support: Lc = 5.2 ft max.

Conditions

Actual Size is 5-3/4 x 10-3/8 in.

Min Bearing Length R1= 0.9 in. R2= 0.9 in. (1.0) DL Defl= 0.17 in Recom Camber= 0.25 in

Data

Beam Span	14.0 ft	Reaction 1 LL	1128 #	Reaction 2 LL	1302 #
Beam Wt per ft	26.0 #	Reaction 1 TL	6240 #	Reaction 2 TL	5248 #
Bm Wt Included	364 #	Maximum V	6240 #		
Max Moment	28276 #'	Max V (Reduced)	N/A		
TL Max Defl	L / 240	TL Actual Defl	L / 757		
LL Max Defl	L / 480	LL Actual Defl	L / >1000		

Attributes

	Section (in ³)	Shear (in ²)	TL Defl (in)	LL Defl
Actual	27.90	2.69	0.22	0.06
Critical	10.28	0.31	0.70	0.35
Status	OK	OK	OK	OK
Ratio	37%	12%	32%	16%

Values

	Fb (psi)	Fv (psi)	E (psi x mil)
Ref. Value Fy	50000	50000	29.0
Adjusted Values	33000	20000	29.0

Adjustments

YP Factor, Lc	0.66	0.40
At Point Loads: Provide these minimum bearing lengths in inches or provide web stiffeners. B = 0.9 C = 0.9		

Loads

Point LL	Point TL	Distance	Par Unif TL	Start	End
2430	B = 4170	7.5	H = 406	0	3.0
	C = 546	3.0	I = 792	3.0	7.5
			J = 250	7.5	14.0

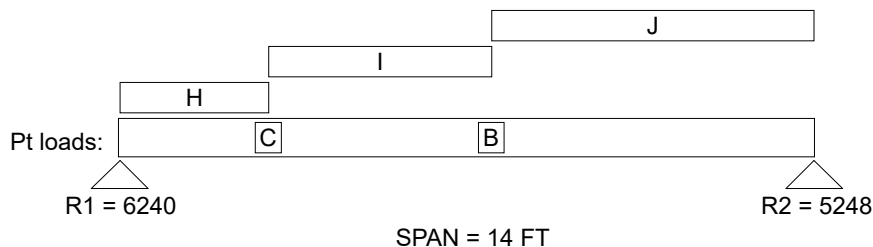

Uniform and partial uniform loads are lbs per lineal ft.

Yang Residence

Upper Floor Framing Plan

B8 (Overstrengthen)

Date: 6/28/19

Selection **W 10x 26 50 ksi Wide Flange Steel** Lateral Support: Lc = 5.2 ft max.

Conditions Actual Size is 5-3/4 x 10-3/8 in.
Min Bearing Length R1= 0.9 in. R2= 0.9 in. (1.0) DL Defl= 0.35 in Recom Camber= 0.53 in

Data

Beam Span	14.0 ft				
Beam Wt per ft	26.0 #	Reaction 1 TL	9071 #	Reaction 2 TL	8226 #
Bm Wt Included	364 #	Maximum V	9071 #		
Max Moment	46810 #'	Max V (Reduced)	N/A		
TL Max Defl	L / 240	TL Actual Defl	L / 479		

Attributes

	Section (in ³)	Shear (in ²)	TL Defl (in)
Actual	27.90	2.69	0.35
Critical	17.02	0.45	0.70
Status	OK	OK	OK
Ratio	61%	17%	50%

Values

	Fb (psi)	Fv (psi)	E (psi x mil)
Ref. Value Fy	50000	50000	29.0
Adjusted Values	33000	20000	29.0

Adjustments

YP Factor, Lc	0.66	0.40
---------------	------	------

At Point Loads: Provide these minimum bearing lengths in inches or provide web stiffeners.
B = 0.9 C = 0.9

Loads

Point TL	Distance	Par Unif TL	Start	End
B = 8930	7.5	H = 467	0	3.0
C = 630	3.0	I = 911	3.0	7.5
		J = 288	7.5	14.0

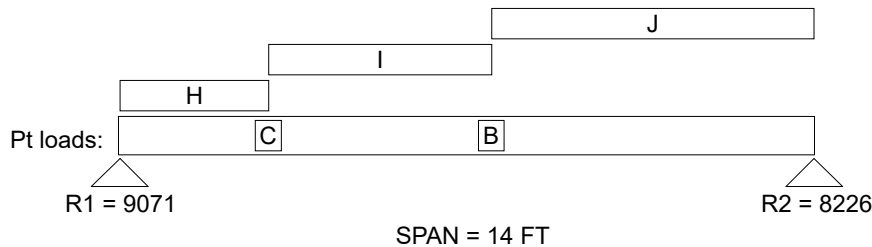

Uniform and partial uniform loads are lbs per lineal ft.

UPPER FLOOR FRMG CONT...

B11

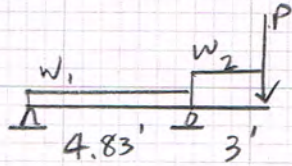

D+L: $w_1 = 22.5 \text{ PLF DL}$
 $w_2 = 75(3/2) = 113 \text{ PLF (90 PLF LL)}$
 $P = 2.14 \text{ k (1.2 k LL)}$
 $f_b = 1399 \text{ psi}$
 $f_v = 82 \text{ psi}$
 $\Delta_{TV} = L/1000$

$5\frac{1}{2} \times 9 \text{ GLB}$
 $R_1 = -1.6 \text{ k}$
 $R_2 = 4.27 \text{ k (2.423 k LL)}$

B12

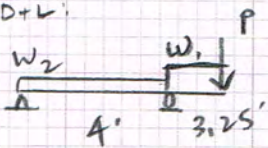

D+L:
 $P = 75(3/2)(8/2) = 0.45 \text{ k (0.36 k LL)}$
 $w_1 = 40 \text{ PLF DL}$ $w_2 = 13.3 \text{ PLF DL}$
 $f_b = 412 \text{ psi}$
 $f_v = 28 \text{ psi}$
 $\Delta_{TV} = L/1000$

4×10
 $R_1 = -0.39 \text{ k}$
 $R_2 = 1.08 \text{ k (0.653 k LL)}$

B13

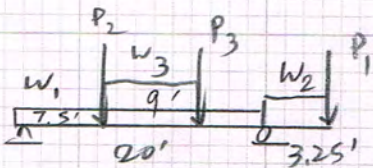

D+L:
 $P_2 = 0.67 \text{ k (0.48 k LL)}$
 $P_3 = 0.358 \text{ k (0.22 k LL)}$
 $w_1 = 65(1.33) = 86.5 \text{ PLF (53.2 PLF LL)}$
 $w_2 = 40 \text{ PLF DL}$ $w_3 = 65(5.5/2) = 179 \text{ PLF (110 PLF LL)}$
 $P_1 = 1.29 \text{ k (0.691 k LL)}$
 $f_b = 897 \text{ psi}$
 $f_v = 56 \text{ psi}$
 $\Delta_{TV} = L/432$

$5\frac{1}{4} \times 11\frac{7}{8} \text{ RSL}$
 $R_1 = 1.69 \text{ k (0.921 k LL)}$
 $R_2 = 3.82 \text{ k (1.98 k LL)}$

B14

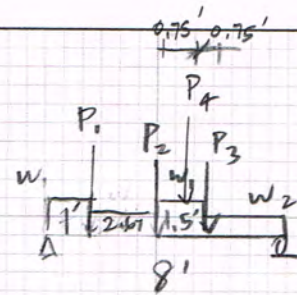

D+L:
 $w_1 = 75(20/2) + 10(4+10.2) + 65(20/2) + 75(3/2) = 1655 \text{ PLF (1090 PLF LL)}$
 $w_2 = 65(20/2) + 75(3/2) = 763 \text{ PLF (490 PLF LL)}$
 $P_1 = P_2 = [75(20/2) + 40] \frac{2.67}{2} = 1.055 \text{ k (0.801 k LL)}$
 $P_3 = [75(20/2) + 40] \frac{4.08}{2} = 1.612 \text{ k (1.224 k LL)}$
 $P_4 = \frac{3.82}{2} = 1.91 \text{ k (1.18 k LL)}$
 $W 8 \times 21$ $b = 5\frac{1}{4}"$
 $d = 8\frac{1}{4}"$
 $R_1 = 8.39 \text{ k (5.4 k LL)}$
 $R_2 = 7.7 \text{ k (4.85 k LL)}$
 SEE B14 OUTPUT ON PG 68

D+W:
 $w_1 = 565 \text{ PLF DL}$
 $w_2 = 273 \text{ PLF DL}$
 $P_1 = 0.254 + 0.243(9.08) = 2.5 \text{ k}$
 $P_2 = 0.254 \text{ k DL}$
 $P_3 = 0.39 \text{ k DL}$
 $P_4 = \frac{1.84}{2} = 0.92 \text{ k DL}$
 $W 8 \times 21$ $R_1 = 7.04 \text{ k (4.33 k LL)}$
 $R_2 = 3.163 \text{ k (0.62 k LL)}$
 SEE B14 (D+W) OUTPUT ON PG 69

PROJECT

DATE 6/27/19

YANG RES.

PROJ. NO. 19-065

DESIGN CKS

SHEET 67

Yang Residence

Upper Floor Framing Plan

B14 (D+L)

Date: 6/28/19

Selection

W 8x 21 50 ksi Wide Flange Steel

Lateral Support: Lc = 4.7 ft max.

Conditions

Actual Size is 5-1/4 x 8-1/4 in.

Min Bearing Length R1= 0.8 in. R2= 0.8 in. (1.0) DL Defl= 0.04 in Recom Camber= 0.06 in

Data

Beam Span	8.0 ft	Reaction 1 LL	5379 #	Reaction 2 LL	4847 #
Beam Wt per ft	21.0 #	Reaction 1 TL	8345 #	Reaction 2 TL	7699 #
Bm Wt Included	168 #	Maximum V	8345 #		
Max Moment	21056 #	Max V (Reduced)	N/A		
TL Max Defl	L / 360	TL Actual Defl	L / 923		
LL Max Defl	L / 480	LL Actual Defl	L / >1000		

Attributes

	Section (in ³)	Shear (in ²)	TL Defl (in)	LL Defl
Actual	18.20	2.07	0.10	0.07
Critical	7.66	0.42	0.27	0.20
Status	OK	OK	OK	OK
Ratio	42%	20%	39%	33%

Values

	Fb (psi)	Fv (psi)	E (psi x mil)
Ref. Value Fy	50000	50000	29.0
Adjusted Values	33000	20000	29.0

Adjustments

YP Factor, Lc	0.66	0.40	
At Point Loads: Provide these minimum bearing lengths in inches or provide web stiffeners.			
B = 0.8	C = 0.8	D = 0.8	E = 0.8

Loads

Point LL	Point TL	Distance	Par Unif LL	Par Unif TL	Start	End
801	B = 1055	1.0	1090	H = 1655	0	1.0
801	C = 1055	3.67	490	I = 763	1.0	3.67
1224	D = 1612	5.17	1090	J = 1655	3.67	5.17
1980	E = 3820	4.42	490	K = 763	5.17	8.0

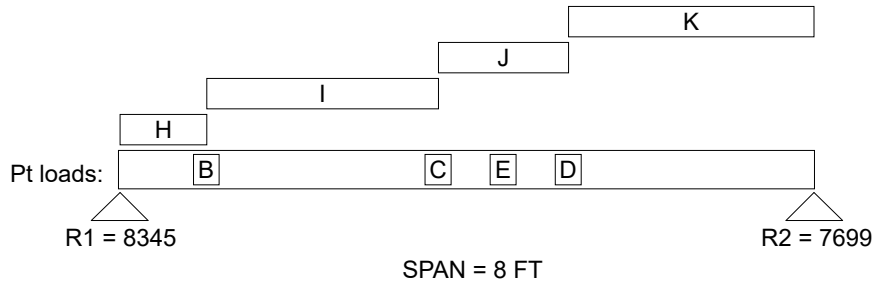

Uniform and partial uniform loads are lbs per lineal ft.

Yang Residence
B14 (D+W)

Upper Floor Framing Plan

Date: 6/28/19

Selection

W 8x 21 50 ksi Wide Flange Steel

Lateral Support: Lc = 4.7 ft max.

Conditions

Actual Size is 5-1/4 x 8-1/4 in.

Min Bearing Length R1= 0.8 in. R2= 0.8 in. (1.0) DL Defl= 0.04 in Recom Camber= 0.06 in

Data

Beam Span	8.0 ft	Reaction 1 LL	1934 #	Reaction 2 LL	276 #
Beam Wt per ft	21.0 #	Reaction 1 TL	4927 #	Reaction 2 TL	3111 #
Bm Wt Included	168 #	Maximum V	4927 #		
Max Moment	8933 #'	Max V (Reduced)	N/A		
TL Max Defl	L / 360	TL Actual Defl	L / >1000		
LL Max Defl	L / 480	LL Actual Defl	L / >1000		

Attributes

	Section (in ³)	Shear (in ²)	TL Defl (in)	LL Defl
Actual	18.20	2.07	0.05	<0.01
Critical	3.25	0.25	0.27	0.20
Status	OK	OK	OK	OK
Ratio	18%	12%	17%	4%

Values

	Fb (psi)	Fv (psi)	E (psi x mil)
Ref. Value Fy	50000	50000	29.0
Adjusted Values	33000	20000	29.0

Adjustments

YP Factor, Lc	0.66	0.40	
At Point Loads: Provide these minimum bearing lengths in inches or provide web stiffeners.			
B = 0.8	C = 0.8	D = 0.8	E = 0.8

Loads

Point LL	Point TL	Distance	Par Unif TL	Start	End
2210	B = 2500	1.0	H = 565	0	1.0
	C = 254	3.67	I = 273	1.0	3.67
	D = 390	5.17	J = 565	3.67	5.17
	E = 1840	4.42	K = 263	5.17	8.0

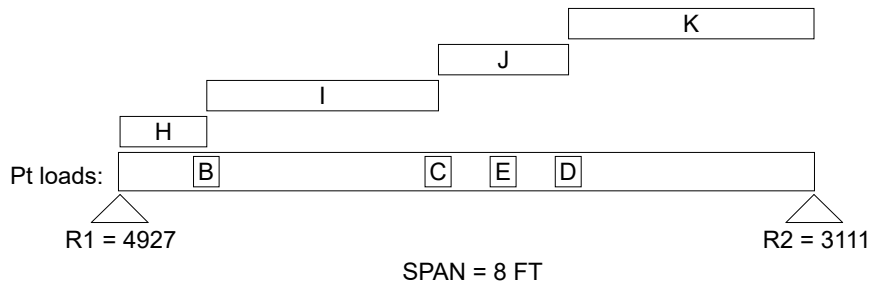

Uniform and partial uniform loads are lbs per lineal ft.

UPPER FLR FRMG CONT, ...

B14 CONT...

1.15D + 0.9E - OVERSTRENGTH - f_b check only

$W_1 = 650 \text{ PLF}$

$W_2 = 314 \text{ PLF}$

$P_1 = 0.292 + 2.5(3.74) = 9.642 \text{ K}$

$P_2 = 0.292 \text{ K}$

$P_3 = 0.45 \text{ K}$

$P_4 = 2.12 \text{ K}$

W8 x 21 OK

SEE B14 (OVERSTRENGTH) OUTPUT ON G11

B15 D+L:

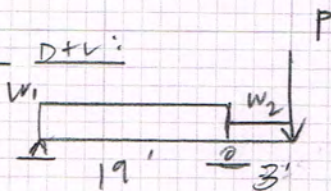

$W_1 = 75(4\frac{1}{2}) + 40 = 190 \text{ PLF} (120 \text{ PLF LL})$

$W_2 = 40 \text{ PLF DL}$

$P = [75(3\frac{1}{2}) + 40](\frac{14}{2}) = 1.068 \text{ K} (0.63 \text{ K LL})$

C12 x 21.7

C12 x 20.7

$R_1 = 1.754 \text{ K} (1.041 \text{ K LL})$

$R_2 = 3.35 \text{ K} (1.87 \text{ K LL})$

SEE B15 OUTPUT ON PG G13

B16

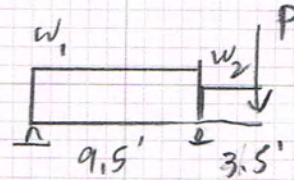

D+L:

$W_1 = 65(19\frac{1}{2}) + 75(3\frac{1}{2}) = 730 \text{ PLF} (470 \text{ PLF LL})$

$W_2 = 75(3\frac{1}{2}) = 113 \text{ PLF} (90 \text{ PLF LL})$

$P = 3.34 \text{ K} (1.87 \text{ K LL})$

W8 x 21 $b = 5\frac{1}{4}$ "

$R_1 = 2.25 \text{ K} (1.49 \text{ K LL})$ $d = 8\frac{1}{4}$ "

$R_2 = 8.693 \text{ K} (5.164 \text{ K LL})$

SEE B16 OUTPUT ON G12

B17 D+L:

$l = 4.67'$

$W = 65(33\frac{1}{2}) = 1073 \text{ PLF} (660 \text{ PLF LL})$

$f_b = 826 \text{ PSI} (2) 2 \times 10$

$f_v = 136 \text{ PSI} R = 2.521 \text{ K}$

$\Delta_{TV} = L/71000 (1.541 \text{ K LL})$

PROJECT

YANG RES.

DATE 6/27/19

PROJ. NO. 19-065

DESIGN CKS

SHEET G10

G11

BeamChek v2018 licensed to: Nickerson Engineering, LLC Reg # 6181-66005

Yang Residence

Upper Floor Framing Plan

B14 (Overstrength)

Date: 6/28/19

Selection **W 8x 21 50 ksi Wide Flange Steel** Lateral Support: Lc = 4.7 ft max.

Conditions Actual Size is 5-1/4 x 8-1/4 in.
Min Bearing Length R1= 0.8 in. R2= 0.8 in. (1.0) DL Defl= 0.08 in Recom Camber= 0.12 in

Data

Beam Span	8.0 ft				
Beam Wt per ft	21.0 #	Reaction 1 TL	11583 #	Reaction 2 TL	4441 #
Bm Wt Included	168 #	Maximum V	11583 #		
Max Moment	13451 #	Max V (Reduced)	N/A		
TL Max Defl	L / 360	TL Actual Defl	L / >1000		

Attributes

	Section (in ³)	Shear (in ²)	TL Defl (in)
Actual	18.20	2.07	0.08
Critical	4.89	0.58	0.27
Status	OK	OK	OK
Ratio	27%	28%	29%

Values

	Fb (psi)	Fv (psi)	E (psi x mil)
Ref. Value Fy	50000	50000	29.0
Adjusted Values	33000	20000	29.0

Adjustments

YP Factor, Lc	0.66	0.40	
---------------	------	------	--

At Point Loads: Provide these minimum bearing lengths in inches or provide web stiffeners.
B = 0.8 C = 0.8 D = 0.8 E = 0.8

Loads

Point TL	Distance	Par Unif TL	Start	End
B = 9642	1.0	H = 650	0	1.0
C = 292	3.67	I = 314	1.0	3.67
D = 450	5.17	J = 650	3.67	5.17
E = 2120	4.42	K = 314	5.17	8.0

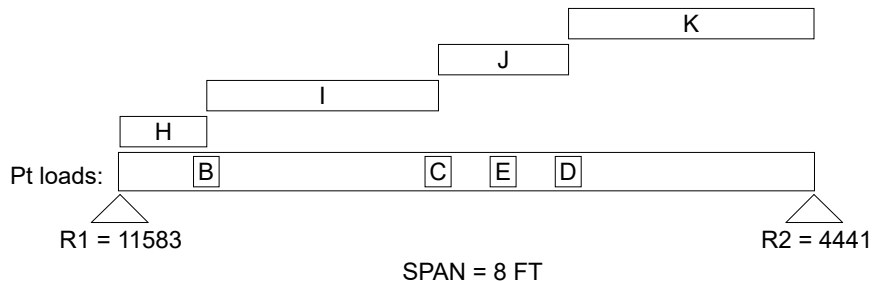

Uniform and partial uniform loads are lbs per lineal ft.

G12

BeamChek v2018 licensed to: Nickerson Engineering, LLC Reg # 6181-66005

Yang Residence

Upper Floor Framing Plan

B16

Date: 6/28/19

Selection **W 8x 21 50 ksi Wide Flange Steel** Lateral Support: Lc = 4.7 ft max.

Conditions Actual Size is 5-1/4 x 8-1/4 in., Overhang
Min Bearing Length R1= 0.8 in. R2= 0.8 in. (1.0) DL Defl= 0.04 in.

Data

Beam Span	9.5 ft	Reaction 1 LL	1486 #	Reaction 2 LL	5164 #
Beam Wt per ft	21.0 #	Reaction 1 TL	2250 #	Reaction 2 TL	8693 #
Bm Wt Included	273 #	Maximum V	4884 #	Overhang Length	3.5 ft
Max Moment	12511 #	Max V (Reduced)	N/A	Total Beam Length	13.0 ft
TL Max Defl	L / 360	TL Actual Defl	L / >1000	OH TL Actual Defl	L / >1000
LL Max Defl	L / 480	LL Actual Defl	L / >1000	OH LL Actual Defl	L / >1000

Attributes

	Section (in ³)	Shear (in ²)	TL Defl (in)	LL Defl	OH TL Defl	OH LL Defl
Actual	18.20	2.07	0.01	<0.01	0.07	0.04
Critical	4.53	0.24	0.32	0.24	0.23	0.18
Status	OK	OK	OK	OK	OK	OK
Ratio	25%	12%	2%	3%	31%	20%

Values

	Fb (psi)	Fv (psi)	E (psi x mil)
Ref. Value Fy	50000	50000	29.0
Adjusted Values	33000	20000	29.0

Adjustments

YP Factor, Lc	0.66	0.40
---------------	------	------

At Point Loads: Provide these minimum bearing lengths in inches or provide web stiffeners.
F = 0.8

Loads

	Uniform LL: 470		Uniform TL: 730 = A		(Uniform Ld on Backspan)	
Point LL	Point TL	Distance	Par Unif LL	Par Unif TL	Start	End
1870	F = 3340 (OH)	3.5	90	K = 113 (OH)	0	3.5

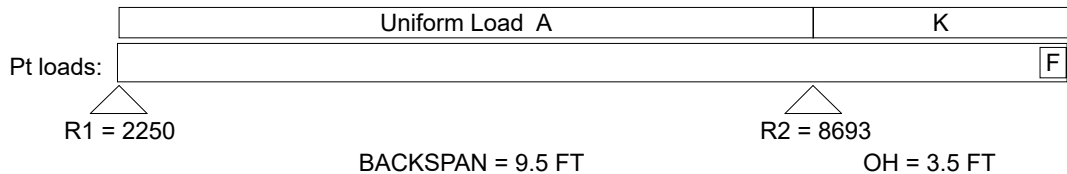

Uniform and partial uniform loads are lbs per lineal ft. Overhanging load distances are from R2.

G13

BeamChek v2018 licensed to: Nickerson Engineering, LLC Reg # 6181-66005

Yang Residence

Upper Floor Framing

B15

Date: 6/28/19

Selection **C 12x 20.7 50 ksi Steel Channel** Lateral Support: Lu = 4.1 ft max.

Conditions Actual Size is 3 x 12 in., Overhang
 Min Bearing Length R1= 1.1 in. R2= 1.1 in. (1.0) DL Defl= 0.05 in.

Data

Beam Span	19.0 ft	Reaction 1 LL	1041 #	Reaction 2 LL	1869 #
Beam Wt per ft	20.7 #	Reaction 1 TL	1819 #	Reaction 2 TL	3435 #
Bm Wt Included	455 #	Maximum V	2185 #	Overhang Length	3.0 ft
Max Moment	7705 #	Max V (Reduced)	N/A	Total Beam Length	22.0 ft
TL Max Defl	L / 360	TL Actual Defl	L / >1000	OH TL Actual Defl	L / < -1000
LL Max Defl	L / 480	LL Actual Defl	L / >1000	OH LL Actual Defl	L / < -1000

Attributes

	Section (in ³)	Shear (in ²)	TL Defl (in)	LL Defl	OH TL Defl	OH LL Defl
Actual	21.50	3.38	0.13	0.07	-0.05	-0.03
Critical	3.08	0.11	0.63	0.48	0.20	0.15
Status	OK	OK	OK	OK	OK	OK
Ratio	14%	3%	20%	16%	25%	19%

Values

	Fb (psi)	Fv (psi)	E (psi x mil)
Ref. Value Fy	50000	50000	29.0
Adjusted Values	30000	20000	29.0

Adjustments

YP Factor, Lu	0.60	0.40
---------------	------	------

At Point Loads: Provide these minimum bearing lengths in inches or provide web stiffeners.
 F = 1.1

Loads

	Uniform LL: 120		Uniform TL: 190 = A		(Uniform Ld on Backspan)	
Point LL	Point TL	Distance	Par Unif TL	Start	End	
630	F = 1068 (OH)	3.0	K = 40 (OH)	0	3.0	

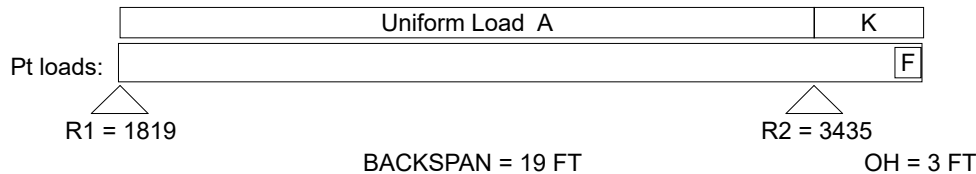

Uniform and partial uniform loads are lbs per lineal ft. Overhanging load distances are from R2.

Roof Deck, Deck: Joist
1 piece(s) 11 7/8" TJI @ 560 @ 16" OC

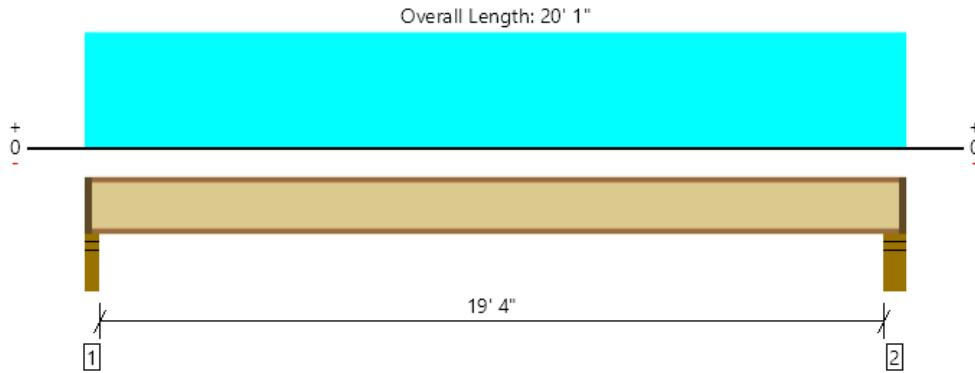

All locations are measured from the outside face of left support (or left cantilever end). All dimensions are horizontal.

Design Results	Actual @ Location	Allowed	Result	LDF	Load: Combination (Pattern)
Member Reaction (lbs)	981 @ 2 1/2"	1265 (1.75")	Passed (78%)	1.00	1.0 D + 1.0 L (All Spans)
Shear (lbs)	967 @ 3 1/2"	2050	Passed (47%)	1.00	1.0 D + 1.0 L (All Spans)
Moment (Ft-lbs)	4753 @ 9' 11 1/2"	9500	Passed (50%)	1.00	1.0 D + 1.0 L (All Spans)
Live Load Defl. (in)	0.419 @ 9' 11 1/2"	0.488	Passed (L/558)	--	1.0 D + 1.0 L (All Spans)
Total Load Defl. (in)	0.524 @ 9' 11 1/2"	0.975	Passed (L/446)	--	1.0 D + 1.0 L (All Spans)
TJ-Pro™ Rating	50	45	Passed	--	--

System : Floor
Member Type : Joist
Building Use : Residential
Building Code : IBC 2015
Design Methodology : ASD

- Deflection criteria: LL (L/480) and TL (L/240).
- Top Edge Bracing (Lu): Top compression edge must be braced at 8' 1" o/c unless detailed otherwise.
- Bottom Edge Bracing (Lu): Bottom compression edge must be braced at 19' 10" o/c unless detailed otherwise.
- A structural analysis of the deck has not been performed.
- Deflection analysis is based on composite action with a single layer of 23/32" Weyerhaeuser Edge™ Panel (24" Span Rating) that is glued and nailed down.
- Additional considerations for the TJ-Pro™ Rating include: 1/2" Gypsum ceiling.

Supports	Bearing Length			Loads to Supports (lbs)			Accessories
	Total	Available	Required	Dead	Floor Live	Total	
1 - Stud wall - HF	3.50"	1.75"	1.75"	199	797	996	1 3/4" Rim Board
2 - Stud wall - HF	5.50"	3.75"	1.75"	203	810	1013	1 3/4" Rim Board

• Rim Board is assumed to carry all loads applied directly above it, bypassing the member being designed.

Vertical Load	Location (Side)	Spacing	Dead (0.90)	Floor Live (1.00)	Comments
1 - Uniform (PSF)	0 to 20' 1"	16"	15.0	60.0	Default Load

Weyerhaeuser Notes

Weyerhaeuser warrants that the sizing of its products will be in accordance with Weyerhaeuser product design criteria and published design values. Weyerhaeuser expressly disclaims any other warranties related to the software. Use of this software is not intended to circumvent the need for a design professional as determined by the authority having jurisdiction. The designer of record, builder or framer is responsible to assure that this calculation is compatible with the overall project. Accessories (Rim Board, Blocking Panels and Squash Blocks) are not designed by this software. Products manufactured at Weyerhaeuser facilities are third-party certified to sustainable forestry standards. Weyerhaeuser Engineered Lumber Products have been evaluated by ICC-ES under evaluation reports ESR-1153 and ESR-1387 and/or tested in accordance with applicable ASTM standards. For current code evaluation reports, Weyerhaeuser product literature and installation details refer to www.weyerhaeuser.com/woodproducts/document-library.

The product application, input design loads, dimensions and support information have been provided by CKS



ForteWEB Software Operator	Job Notes
Chris Smpliciano Nickerson Engineering, LLC (425) 610-4425 simpliciano@nickersonengineering.com	

Upper Floor, Floor: Joist (19.33' Span)
 1 piece(s) 11 7/8" TJI @ 560 @ 16" OC

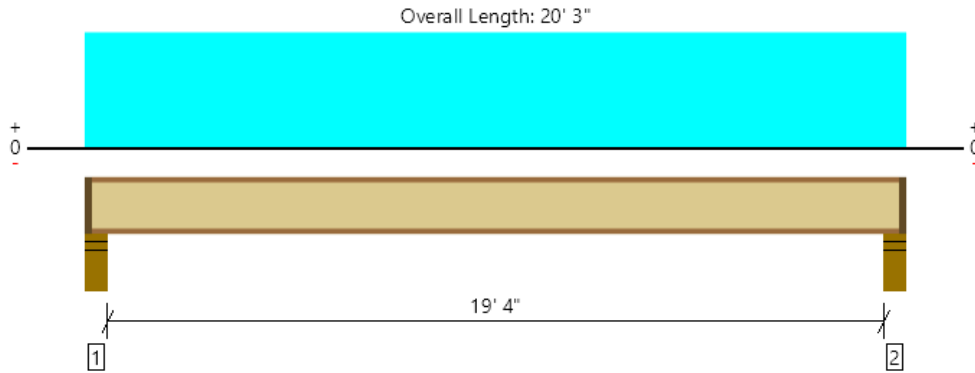

All locations are measured from the outside face of left support (or left cantilever end). All dimensions are horizontal.

Design Results	Actual @ Location	Allowed	Result	LDF	Load: Combination (Pattern)
Member Reaction (lbs)	865 @ 4 1/2"	1725 (3.50")	Passed (50%)	1.00	1.0 D + 1.0 L (All Spans)
Shear (lbs)	838 @ 5 1/2"	2050	Passed (41%)	1.00	1.0 D + 1.0 L (All Spans)
Moment (Ft-lbs)	4119 @ 10' 1 1/2"	9500	Passed (43%)	1.00	1.0 D + 1.0 L (All Spans)
Live Load Defl. (in)	0.280 @ 10' 1 1/2"	0.488	Passed (L/837)	--	1.0 D + 1.0 L (All Spans)
Total Load Defl. (in)	0.454 @ 10' 1 1/2"	0.975	Passed (L/515)	--	1.0 D + 1.0 L (All Spans)
TJ-Pro™ Rating	50	45	Passed	--	--

System : Floor
 Member Type : Joist
 Building Use : Residential
 Building Code : IBC 2015
 Design Methodology : ASD

- Deflection criteria: LL (L/480) and TL (L/240).
- Top Edge Bracing (Lu): Top compression edge must be braced at 8' 9" o/c unless detailed otherwise.
- Bottom Edge Bracing (Lu): Bottom compression edge must be braced at 20' o/c unless detailed otherwise.
- A structural analysis of the deck has not been performed.
- Deflection analysis is based on composite action with a single layer of 23/32" Weyerhaeuser Edge™ Panel (24" Span Rating) that is glued and nailed down.
- Additional considerations for the TJ-Pro™ Rating include: 1/2" Gypsum ceiling.

Supports	Bearing Length			Loads to Supports (lbs)			Accessories
	Total	Available	Required	Dead	Floor Live	Total	
1 - Stud wall - HF	5.50"	3.75"	1.75"	338	540	878	1 3/4" Rim Board
2 - Stud wall - HF	5.50"	3.75"	1.75"	338	540	878	1 3/4" Rim Board

- Rim Board is assumed to carry all loads applied directly above it, bypassing the member being designed.

Vertical Load	Location (Side)	Spacing	Dead (0.90)	Floor Live (1.00)	Comments
1 - Uniform (PSF)	0 to 20' 3"	16"	25.0	40.0	Default Load

Weyerhaeuser Notes

Weyerhaeuser warrants that the sizing of its products will be in accordance with Weyerhaeuser product design criteria and published design values. Weyerhaeuser expressly disclaims any other warranties related to the software. Use of this software is not intended to circumvent the need for a design professional as determined by the authority having jurisdiction. The designer of record, builder or framer is responsible to assure that this calculation is compatible with the overall project. Accessories (Rim Board, Blocking Panels and Squash Blocks) are not designed by this software. Products manufactured at Weyerhaeuser facilities are third-party certified to sustainable forestry standards. Weyerhaeuser Engineered Lumber Products have been evaluated by ICC-ES under evaluation reports ESR-1153 and ESR-1387 and/or tested in accordance with applicable ASTM standards. For current code evaluation reports, Weyerhaeuser product literature and installation details refer to www.weyerhaeuser.com/woodproducts/document-library.

The product application, input design loads, dimensions and support information have been provided by CKS



ForteWEB Software Operator	Job Notes
Chris Smpliciano Nickerson Engineering, LLC (425) 610-4425 simpliciano@nickersonengineering.com	

Upper Floor, Floor: Joist (20.16' Span)
 1 piece(s) 11 7/8" TJI @ 560 @ 16" OC

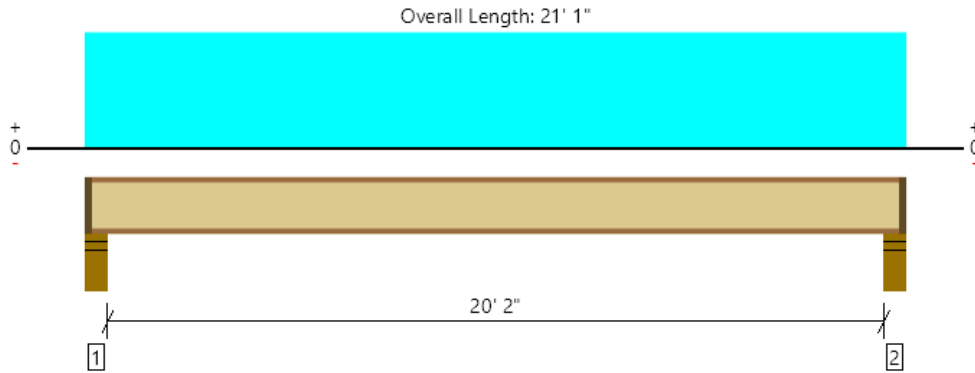

All locations are measured from the outside face of left support (or left cantilever end). All dimensions are horizontal.

Design Results	Actual @ Location	Allowed	Result	LDF	Load: Combination (Pattern)
Member Reaction (lbs)	901 @ 4 1/2"	1725 (3.50")	Passed (52%)	1.00	1.0 D + 1.0 L (All Spans)
Shear (lbs)	874 @ 5 1/2"	2050	Passed (43%)	1.00	1.0 D + 1.0 L (All Spans)
Moment (Ft-lbs)	4479 @ 10' 6 1/2"	9500	Passed (47%)	1.00	1.0 D + 1.0 L (All Spans)
Live Load Defl. (in)	0.327 @ 10' 6 1/2"	0.508	Passed (L/747)	--	1.0 D + 1.0 L (All Spans)
Total Load Defl. (in)	0.531 @ 10' 6 1/2"	1.017	Passed (L/459)	--	1.0 D + 1.0 L (All Spans)
TJ-Pro™ Rating	47	45	Passed	--	--

System : Floor
 Member Type : Joist
 Building Use : Residential
 Building Code : IBC 2015
 Design Methodology : ASD

- Deflection criteria: LL (L/480) and TL (L/240).
- Top Edge Bracing (Lu): Top compression edge must be braced at 8' 4" o/c unless detailed otherwise.
- Bottom Edge Bracing (Lu): Bottom compression edge must be braced at 20' 10" o/c unless detailed otherwise.
- A structural analysis of the deck has not been performed.
- Deflection analysis is based on composite action with a single layer of 23/32" Weyerhaeuser Edge™ Panel (24" Span Rating) that is glued and nailed down.
- Additional considerations for the TJ-Pro™ Rating include: 1/2" Gypsum ceiling.

Supports	Bearing Length			Loads to Supports (lbs)			Accessories
	Total	Available	Required	Dead	Floor Live	Total	
1 - Stud wall - HF	5.50"	3.75"	1.75"	351	562	913	1 3/4" Rim Board
2 - Stud wall - HF	5.50"	3.75"	1.75"	351	562	913	1 3/4" Rim Board

• Rim Board is assumed to carry all loads applied directly above it, bypassing the member being designed.

Vertical Load	Location (Side)	Spacing	Dead (0.90)	Floor Live (1.00)	Comments
1 - Uniform (PSF)	0 to 21' 1"	16"	25.0	40.0	Default Load

Weyerhaeuser Notes

Weyerhaeuser warrants that the sizing of its products will be in accordance with Weyerhaeuser product design criteria and published design values. Weyerhaeuser expressly disclaims any other warranties related to the software. Use of this software is not intended to circumvent the need for a design professional as determined by the authority having jurisdiction. The designer of record, builder or framer is responsible to assure that this calculation is compatible with the overall project. Accessories (Rim Board, Blocking Panels and Squash Blocks) are not designed by this software. Products manufactured at Weyerhaeuser facilities are third-party certified to sustainable forestry standards. Weyerhaeuser Engineered Lumber Products have been evaluated by ICC-ES under evaluation reports ESR-1153 and ESR-1387 and/or tested in accordance with applicable ASTM standards. For current code evaluation reports, Weyerhaeuser product literature and installation details refer to www.weyerhaeuser.com/woodproducts/document-library.

The product application, input design loads, dimensions and support information have been provided by CKS



ForTEWEB Software Operator	Job Notes
Chris Smpliciano Nickerson Engineering, LLC (425) 610-4425 simpliciano@nickersonengineering.com	

Seismic Design Loads (ASCE 7-10)

for a Wood Framed Structure

OCCUPANCY CAT. II Table 1.5-1
 IMP. FACTOR 1 Table 1.5-2
 SITE CLASS D Table 20.3-1
 R = 6.5 Table 12.2-1
 h = 27.24 ft

$S_S = 1.452$ 2010 ASCE 7 Standard (<http://geohazards.usgs.gov/designmaps>)
 $S_1 = 0.553$ 2010 ASCE 7 Standard (<http://geohazards.usgs.gov/designmaps>)
 $S_{MS} = 1.452$ Table 11.4-1
 $S_{M1} = 0.83$ Table 11.4-2
 $S_{DS} = 0.968$
 $S_{D1} = 0.553333333$

Period, T = 0.238470863 Eqn. 12.8-7
 $C_s = 0.148923077$ Eqn. 12.8-2
 $C_{smax} = 0.356975289$ Eqn. 12.8-3
 $C_{smin} = 0.01$ Eqn. 12.8-5

Base Shear, V = 10518 lbs (ASD)

Shearwalls	DL (psf)	A (sq.ft.)	W (#'s)	h_x (ft)	$W \cdot h_x$	C_{vx}	Lat. Load (lbs)
2nd Flr Shearwalls	25	2300	57500	23.5	1351250	0.727537	7653
1st Flr Shearwalls	20	2170	43400	11.66	506044	0.272463	2866
		Sum=	100900	Sum=	1857294		

Diaphragm Forces (per ASCE 7-10 12.10.1.1)

level	lower limit	upper limit	sum F	sum W	calc'd force	Diaphragm Load (lbs)
Roof	7792.4	15584.8	7653	57500	7652.6	7792
2nd	5881.568	11763.14	10518	100900	4524.3	5882



Project:
 Yang Residence

Date: 6/27/2019
 Project #: 19-065
 Design: CKS

Wind Design Loads (ASCE 7-10)

Directional Procedure

ALL wind directions

Exposure C		Roof Angle =	0	degrees
V= 110	mph	Ground to top of roof	27.24	ft
K _d = 0.85		Bottom of roof to top of roof	0	ft
I= 1		(mean roof height) h=	27.24	ft
G= 0.85				

Table 26.6-1
Table 1.5-2
Section 26.9

Topography from Figure 26.8-1

Terrain=		(ridge, hill, escarpment)
Site=		(UPwind or DOWNwind)
H=	ft	height of topography
L _h =	ft	distance from H/2 to crest>0
x=	ft	distance from crest to site
z=	ft	Height from bottom of topo. to site
μ=	1.5	
γ=	4	
K ₁ value =	1.05	
K ₁ =		
K ₂ =		
K ₃ =		

Pressure Coefficients from Figure 27.4-1:

Bldg Face	C _p
Windward Wall	0.8
Leeward Wall	-0.5
Windward Roof	0
Leeward Roof	-0.6

*Note= Cp values are conservative

worst case values

$K_{zt} = (1+K_1K_2K_3)^2 =$	1.00	Per Mercer Island Wind Map
------------------------------	-------------	----------------------------

Pressures:					
Ht	K _z	0.6*q _z **	P _{ww walls}	P _{lw walls}	P _{walls (psf)}
0-15	0.85	13.43	9.13	6.58	15.71
15-20	0.9	14.22	9.67	6.58	16.25
20-25	0.94	14.85	10.10	6.58	16.68
25-30	0.98	15.48	10.53	6.58	17.11
30-40	1.04	16.43	11.17	6.58	17.75

**NOTE: Wind pressures are ASD

P _{roof (psf)}
7.90



Project:
Yang Residence

Date: 6/27/2019
Project #: 19-065
Design: CKS

Sheet: L2

Wind Forces

Yang Residence

LEVEL

Second Floor Shearwalls

	Pressures	NORTH TO SOUTH Wind Area	Force
$P_{roof} =$	7.90	0.00	0
$P_{30-40} =$	17.75	0.00	0
$P_{25-30} =$	17.11	64.13	1097.097197
$P_{20-25} =$	16.68	265.63	4430.096184
$P_{15-20} =$	16.25	148.55	2413.63983
$P_{0-15} =$	15.71	0.00	0
		SUM	7940.833211

	Pressures	EAST TO WEST Wind Area	Force
$P_{roof} =$	7.90	0.00	0
$P_{30-40} =$	17.75	0.00	0
$P_{25-30} =$	17.11	84.38	1443.521931
$P_{20-25} =$	16.68	231.58	3862.220662
$P_{15-20} =$	16.25	125.49	2038.961038
$P_{0-15} =$	15.71	0.00	0
		SUM	7344.703631

First Floor Shearwalls

	Pressures	Wind Area	Force
$P_{roof} =$	7.90	0.00	0
$P_{30-40} =$	17.75	0.00	0
$P_{25-30} =$	17.11	0.00	0
$P_{20-25} =$	16.68	0.00	0
$P_{15-20} =$	16.25	121.28	1970.556974
$P_{0-15} =$	15.71	503.40	7908.853126
		SUM	9879.4101

	Pressures	Wind Area	Force
$P_{roof} =$	7.90	0.00	0
$P_{30-40} =$	17.75	0.00	0
$P_{25-30} =$	17.11	0.00	0
$P_{20-25} =$	16.68	0.00	0
$P_{15-20} =$	16.25	103.03	1674.031044
$P_{0-15} =$	15.71	424.70	6672.407474
		SUM	8346.438519



Yang Residence

Shear Wall Lengths
Second Floor Shearwalls

	h_{max}	wall 1	wall 2	wall 3	wall 4	wall 5	wall 6	wall 7	wall 8	wall 9	wall 10	SUM
grid 1	10.16	5.83	7.08	15.25								28.16
aspect ratio reduc		5.83	7.08	15.25								28.16
grid 2	10.16	12.16										12.16
aspect ratio reduc		12.16										12.16
grid 3	10.16	15.75										15.75
aspect ratio reduc		15.75										15.75
grid 4	10.16	8.33	3.67									12
aspect ratio reduc		8.33	2.651358									10.98135827
grid 5												0
aspect ratio reduc												0
grid 6												0
aspect ratio reduc												0
grid A	10.16	20.75										20.75
aspect ratio reduc		20.75										20.75
grid B	10.16	6.92										6.92
aspect ratio reduc		6.92										6.92
grid C	10.16	4.16	4.75									8.91
aspect ratio reduc		3.406614173	4.441437									7.848051181
grid D	10.16	3.16	3									6.16
aspect ratio reduc		1.965669291	1.771654									3.737322835
grid E												0
aspect ratio reduc												0
grid F												0
aspect ratio reduc												0

Yang Residence

Shear Wall Lengths
First Floor Shearwalls

	h_{max}	wall 1	wall 2	wall 3	wall 4	wall 5	wall 6	wall 7	wall 8	wall 9	wall 10	SUM
grid 1	11.16	20.16	2	2								24.16
aspect ratio reduc		20.16	1.142857	1.142857								22.44571429
grid 2	11.16	14.16										14.16
aspect ratio reduc		14.16										14.16
grid 3	11.16	5.5										5.5
aspect ratio reduc		5.421146953										5.421146953
grid 4	11.16	8.42	10.67									19.09
aspect ratio reduc		8.42	10.67									19.09
grid 5												0
aspect ratio reduc												0
grid 6												0
aspect ratio reduc												0
grid A	11.16	15.08	8.42									23.5
aspect ratio reduc		15.08	8.42									23.5
grid B	11.16	20.08										20.08
aspect ratio reduc		20.08										20.08
grid C	11.16	7.16	4.75									11.91
aspect ratio reduc		7.16	4.043459									11.20345878
grid D	11.16	4										4
aspect ratio reduc		2.867383513										2.867383513
grid E												0
aspect ratio reduc												0
grid F												0
aspect ratio reduc												0

FORCE DISTRIBUTION

Yang Residence

SECOND FLOOR SHEARWALLS		story shears:										east to west		north to south		holddown
		Vs = 7653					Vw = 7345					Vw = 7941				
grid	V _{seismic} (lbs)	V _{wind} (lbs)	∑ l _{wall s} (ft)	∑ l _{wall w} (ft)	V _{u s} (pif)	V _{u w} (pif)	SW	h (ft)	DL (lbs)	uplift (lbs)						
E to W																
1	1701	1632	28.16	28.16	60	58	SW1	10.16	194	419					NONE	
2	3019	2897	12.16	12.16	248	238	SW2	10.16	308	2214					(2)CS16	
3	2126	2040	15.75	15.75	135	130	SW1	10.16	110	1262					(1)CS16	
4	808	775	10.98	136	74	65	SW1	10.16	435	313					NONE	
5																
6																
N to S																
A	1480	1536	20.75	20.75	71	74	SW1	10.16	1790	-1038					NONE	
B	2382	2472	6.92	6.92	344	357	SW3	10.16	566	3064					(2)CS16	
C	2346	2435	7.84	8.91	299	273	SW2	10.16	265	2773					(2)CS16	
D	1444	1498	3.73	3.23	386	243	SW3	10.16	183	3742					HTT5	
E																
F																

FORCE DISTRIBUTION

Yang Residence

FIRST FLOOR SHEARWALLS		story shears:										holddown	
		Vs = 10518					Vw = 15691					east to west	
							Vw = 17820					north to south	
grid	V _{seismic} (lbs)	V _{wind} (lbs)	Σ l _{wall,s} (ft)	Σ l _{wall,w} (ft)	v _{i,s} (pif)	v _{i,w} (pif)	SW	h (ft)	DL (lbs)	uplift (lbs)	holddown		
E to W													
1	2576	3843	22.44571	24.16	115	159	SW1	11.16	76	1699	HTT5		
2	4240	6324	14.16	14.16	299	447	SW3	11.16	535	4449	HDQ8		
3	2683	4003	5.421147	5.5	495	728	SW4	11.16	208	7914	HDQ8		
4	1020	1521	19.09	19.09	53	80	SW1	11.16	318	571	NONE		
5													
6													
N to S													
A	2034	3446	23.5	23.5	87	147	SW1	11.16	596	1041	HTT5		
B	3275	5548	20.08	20.08	163	276	SW2	11.16	1855	1228	HTT5		
C	3225	5464	11.20346	11.91	288	459	SW4	11.16	319	7573	HDQ8		
D	1985	3362	2.867384	4	692	841	SW4	11.16	299	9082	HDQ8		
E													
F													

This Wall in File:

Enercalc EARTH (c) 1987-2019, Build 11.19.06.12
License : KW-06011484
License To : CKS, KW-06011484

Cantilevered Retaining Wall

Code: IBC 2018,ACI 318-14,TMS 402-16

Criteria

Retained Height	=	4.00 ft
Wall height above soil	=	0.00 ft
Slope Behind Wall	=	0.00
Height of Soil over Toe	=	6.00 in
Water height over heel	=	0.0 ft

Soil Data

Allow Soil Bearing	=	1,500.0 psf
Equivalent Fluid Pressure Method		
Active Heel Pressure	=	35.0 psf/ft
Passive Pressure	=	450.0 psf/ft
Soil Density, Heel	=	125.00 pcf
Soil Density, Toe	=	125.00 pcf
Footings Soil Friction	=	0.525
Soil height to ignore for passive pressure	=	12.00 in

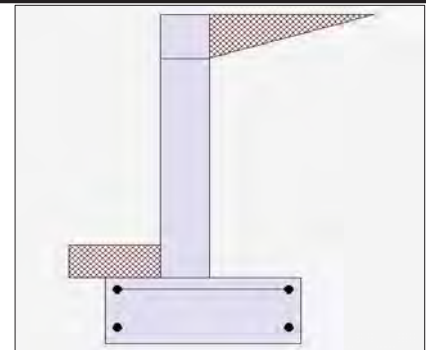

Surcharge Loads

Surcharge Over Heel	=	0.0 psf
Used To Resist Sliding & Overturning		
Surcharge Over Toe	=	0.0 psf
Used for Sliding & Overturning		

Lateral Load Applied to Stem

Lateral Load	=	0.0 #/ft
...Height to Top	=	0.00 ft
...Height to Bottom	=	0.00 ft
Load Type	=	Wind (W) (Service Level)
Wind on Exposed Stem	=	0.0 psf (Service Level)

Adjacent Footing Load

Adjacent Footing Load	=	0.0 lbs
Footing Width	=	0.00 ft
Eccentricity	=	0.00 in
Wall to Ftg CL Dist	=	0.00 ft
Footing Type	=	Line Load
Base Above/Below Soil at Back of Wall	=	0.0 ft
Poisson's Ratio	=	0.300

Axial Load Applied to Stem

Axial Dead Load	=	0.0 lbs
Axial Live Load	=	0.0 lbs
Axial Load Eccentricity	=	0.0 in

Earth Pressure Seismic Load

Method : Uniform		
Multiplier Used	=	8.000
(Multiplier used on soil density)		
Uniform Seismic Force	=	40.000
Total Seismic Force	=	200.000

Design Summary

Wall Stability Ratios

Overturning	=	2.10 OK
Sliding	=	1.83 OK
Total Bearing Load	=	1,474 lbs
...resultant ecc.	=	6.36 in
Soil Pressure @ Toe	=	1,220 psf OK
Soil Pressure @ Heel	=	0 psf OK
Allowable	=	1,500 psf
Soil Pressure Less Than Allowable		
ACI Factored @ Toe	=	1,709 psf
ACI Factored @ Heel	=	0 psf
Footing Shear @ Toe	=	0.5 psi OK
Footing Shear @ Heel	=	5.2 psi OK
Allowable	=	75.0 psi
Sliding Calcs		
Lateral Sliding Force	=	577.5 lbs
less 100% Passive Force	= -	281.3 lbs
less 100% Friction Force	= -	773.9 lbs
Added Force Req'd	=	0.0 lbs OK
....for 1.5 Stability	=	0.0 lbs OK

Stem Construction

	3rd	2nd	Bottom
Design Height Above Ftg	ft = 4.00	ft = 3.33	ft = 0.00
Wall Material Above "Ht"	Concrete	Concrete	Concrete
Design Method	LRFD	LRFD	LRFD
Thickness	= 8.00	= 8.00	= 8.00
Rebar Size	= # 4	= # 4	= # 4
Rebar Spacing	= 12.00	= 12.00	= 12.00
Rebar Placed at	= Edge	= Edge	= Edge
Design Data			
fb/FB + fa/Fa	= -0.001	= 0.001	= 0.168
Total Force @ Section			
Service Level	lbs =		
Strength Level	lbs =	39.4	608.0
Moment....Actual			
Service Level	ft-# =		
Strength Level	ft-# =	11.8	917.3
Moment.....Allowable	ft-# =	5,359.5	5,412.6
Shear.....Actual			
Service Level	psi =		
Strength Level	psi =	0.5	8.1
Shear.....Allowable	psi =	67.1	75.0
Anet (Masonry)	in2 =		
Rebar Depth 'd'	in =	6.25	6.25
Masonry Data			
f'm	psi =		
Fs	psi =		
Solid Grouting	=		
Modular Ratio 'n'	=		
Wall Weight	psf =	100.0	100.0
Short Term Factor	=		
Equiv. Solid Thick.	=		
Masonry Block Type	=	Medium Weight	
Masonry Design Method	=	ASD	
Concrete Data			
fc	psi =	2,000.0	2,000.0
Fy	psi =	60,000.0	60,000.0

Vertical component of active lateral soil pressure IS NOT considered in the calculation of soil bearing

Load Factors

Building Code	IBC 2018,ACI
Dead Load	1.200
Live Load	1.600
Earth, H	1.600
Wind, W	1.000
Seismic, E	1.000

This Wall in File:

Enercalc EARTH (c) 1987-2019, Build 11.19.06.12
License : KW-06011484
License To : CKS, KW-06011484

Cantilevered Retaining Wall

Code: IBC 2018,ACI 318-14,TMS 402-16

Concrete Stem Rebar Area Details

3rd Stem	Vertical Reinforcing	Horizontal Reinforcing	
As (based on applied moment) :	0 in2/ft		
(4/3) * As :	0 in2/ft	Min Stem T&S Reinf Area 0.000 in2	
200bd/fy : 200(12)(6.25)/60000 :	0.25 in2/ft	Min Stem T&S Reinf Area per ft of stem Height : 0.000 in2/ft	
0.0018bh : 0.0018(12)(8) :	0.1728 in2/ft	Horizontal Reinforcing Options :	
	=====	One layer of :	Two layers of :
Required Area :	0.1728 in2/ft	#4@ 0.00 in	#4@ 0.00 in
Provided Area :	0.2 in2/ft	#5@ 0.00 in	#5@ 0.00 in
Maximum Area :	0.6773 in2/ft	#6@ 0.00 in	#6@ 0.00 in

2nd Stem	Vertical Reinforcing	Horizontal Reinforcing	
As (based on applied moment) :	0.0004 in2/ft		
(4/3) * As :	0.0006 in2/ft	Min Stem T&S Reinf Area 0.129 in2	
200bd/fy : 200(12)(6.25)/60000 :	0.25 in2/ft	Min Stem T&S Reinf Area per ft of stem Height : 0.192 in2/ft	
0.0018bh : 0.0018(12)(8) :	0.1728 in2/ft	Horizontal Reinforcing Options :	
	=====	One layer of :	Two layers of :
Required Area :	0.1728 in2/ft	#4@ 12.50 in	#4@ 25.00 in
Provided Area :	0.2 in2/ft	#5@ 19.38 in	#5@ 38.75 in
Maximum Area :	0.6773 in2/ft	#6@ 27.50 in	#6@ 55.00 in

Bottom Stem	Vertical Reinforcing	Horizontal Reinforcing	
As (based on applied moment) :	0.0344 in2/ft		
(4/3) * As :	0.0458 in2/ft	Min Stem T&S Reinf Area 0.639 in2	
200bd/fy : 200(12)(6.25)/60000 :	0.25 in2/ft	Min Stem T&S Reinf Area per ft of stem Height : 0.192 in2/ft	
0.0018bh : 0.0018(12)(8) :	0.1728 in2/ft	Horizontal Reinforcing Options :	
	=====	One layer of :	Two layers of :
Required Area :	0.1728 in2/ft	#4@ 12.50 in	#4@ 25.00 in
Provided Area :	0.2 in2/ft	#5@ 19.38 in	#5@ 38.75 in
Maximum Area :	0.8467 in2/ft	#6@ 27.50 in	#6@ 55.00 in

Footing Data

Toe Width	=	0.75 ft
Heel Width	=	1.92
Total Footing Width	=	2.67
Footing Thickness	=	12.00 in
Key Width	=	0.00 in
Key Depth	=	0.00 in
Key Distance from Toe	=	0.00 ft
f _c =	2,500 psi	F _y = 60,000 psi
Footing Concrete Density	=	150.00 pcf
Min. As %	=	0.0018
Cover @ Top	2.00	@ Btm = 3.00 in

Footing Design Results

		Toe	Heel
Factored Pressure	=	1,709	0 psf
Mu' : Upward	=	5,170	1,410 ft-#
Mu' : Downward	=	861	7,352 ft-#
Mu: Design	=	146	6 ft-#
Actual 1-Way Shear	=	0.49	5.21 psi
Allow 1-Way Shear	=	40.00	40.00 psi
Toe Reinforcing	=	None Spec'd	
Heel Reinforcing	=	# 4 @ 18.00 in	
Key Reinforcing	=	None Spec'd	
Footing Torsion, Tu	=	0.00 ft-lbs	
Footing Allow. Torsion, phi Tu	=	0.00 ft-lbs	

If torsion exceeds allowable, provide supplemental design for footing torsion.

Other Acceptable Sizes & Spacings

Toe: Not req'd: $Mu < \phi * 5 * \lambda * \sqrt{f_c} * S_m$
 Heel: Not req'd: $Mu < \phi * 5 * \lambda * \sqrt{f_c} * S_m$
 Key: No key defined

Min footing T&S reinf Area	0.69	in2
Min footing T&S reinf Area per foot	0.26	in2 /ft
If one layer of horizontal bars:	If two layers of horizontal bars:	
#4@ 9.26 in	#4@ 18.52 in	
#5@ 14.35 in	#5@ 28.70 in	
#6@ 20.37 in	#6@ 40.74 in	

This Wall in File:

Emercalc EARTH (c) 1987-2019, Build 11.19.06.12
License : KW-06011484
License To : CKS, KW-06011484

Cantilevered Retaining Wall

Code: IBC 2018,ACI 318-14,TMS 402-16

Summary of Overturning & Resisting Forces & Moments

ItemOVERTURNING.....		RESISTING.....			
	Force lbs	Distance ft	Moment ft-#	Force lbs	Distance ft	Moment ft-#	
HL Act Pres (ab water tbl)	437.5	1.67	729.2	Soil Over HL (ab. water tbl)	626.7	2.04	1,280.5
HL Act Pres (be water tbl)				Soil Over HL (bel. water tbl)		2.04	1,280.5
Hydrostatic Force				Watre Table			
Buoyant Force =				Sloped Soil Over Heel =			
Surcharge over Heel =				Surcharge Over Heel =			
Surcharge Over Toe =				Adjacent Footing Load =			
Adjacent Footing Load =				Axial Dead Load on Stem =			
Added Lateral Load =				* Axial Live Load on Stem =			
Load @ Stem Above Soil =				Soil Over Toe =	46.9	0.38	17.6
Seismic Earth Load =	140.0	2.50	350.0	Surcharge Over Toe =			
=				Stem Weight(s) =	400.0	1.08	433.3
Total =	577.5	O.T.M. =	1,079.2	Earth @ Stem Transitions =			
				Footing Weight =	400.5	1.34	534.7
				Key Weight =			
				Vert. Component =			
Resisting/Overturning Ratio =			2.10	Total =	1,474.0 lbs	R.M.=	2,266.1
Vertical Loads used for Soil Pressure =		1,474.0 lbs					

* Axial live load NOT included in total displayed, or used for overturning resistance, but is included for soil pressure calculation.

If seismic is included, the OTM and sliding ratios be 1.1 per section 1807.2.3 of IBC 2009 or IBC 201

Vertical component of active lateral soil pressure IS NOT considered in the calculation of Sliding Resistance.

Vertical component of active lateral soil pressure IS NOT considered in the calculation of Overturning Resistance.

Tilt

Horizontal Deflection at Top of Wall due to settlement of soil

(Deflection due to wall bending not considered)

Soil Spring Reaction Modulus 250.0 pci
Horizontal Defl @ Top of Wall (approximate only) 0.000 in

The above calculation is not valid if the heel soil bearing pressure exceeds that of the toe, because the wall would then tend to rotate into the retained soil.

This Wall in File:

Enercalc EARTH (c) 1987-2019, Build 11.19.06.12
License : KW-06011484
License To : CKS, KW-06011484

Cantilevered Retaining Wall

Code: IBC 2018,ACI 318-14,TMS 402-16

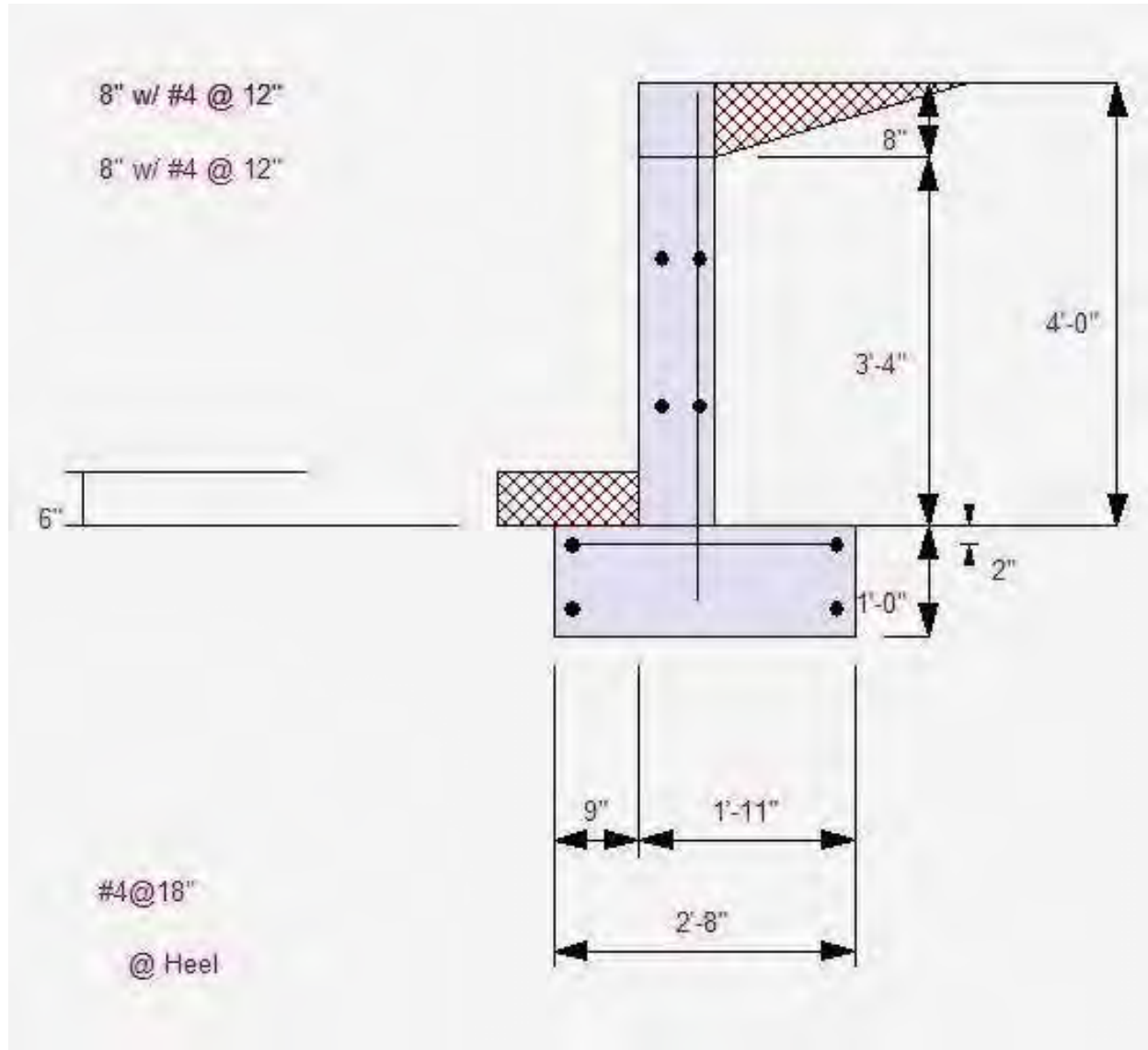

This Wall in File:

Enercalc EARTH (c) 1987-2019, Build 11.19.06.12
 License : KW-06011484
 License To : CKS, KW-06011484

Cantilevered Retaining Wall

Code: IBC 2015,ACI 318-14,ACI 530-13

Criteria

Retained Height	=	5.00 ft
Wall height above soil	=	0.00 ft
Slope Behind Wall	=	0.00
Height of Soil over Toe	=	6.00 in
Water height over heel	=	0.0 ft

Soil Data

Allow Soil Bearing	=	1,995.0 psf
Equivalent Fluid Pressure Method		
Active Heel Pressure	=	35.0 psf/ft
Passive Pressure	=	450.0 psf/ft
Soil Density, Heel	=	125.00 pcf
Soil Density, Toe	=	125.00 pcf
Footings Soil Friction	=	0.525
Soil height to ignore for passive pressure	=	12.00 in

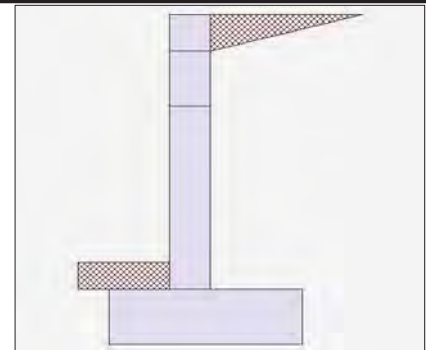

Surcharge Loads

Surcharge Over Heel	=	0.0 psf
Used To Resist Sliding & Overturning		
Surcharge Over Toe	=	0.0 psf
Used for Sliding & Overturning		

Lateral Load Applied to Stem

Lateral Load	=	0.0 #/ft
...Height to Top	=	0.00 ft
...Height to Bottom	=	0.00 ft
Load Type	=	Wind (W) (Service Level)
Wind on Exposed Stem	=	0.0 psf (Service Level)

Adjacent Footing Load

Adjacent Footing Load	=	0.0 lbs
Footing Width	=	0.00 ft
Eccentricity	=	0.00 in
Wall to Ftg CL Dist	=	0.00 ft
Footing Type	=	Line Load
Base Above/Below Soil at Back of Wall	=	0.0 ft
Poisson's Ratio	=	0.300

Axial Load Applied to Stem

Axial Dead Load	=	0.0 lbs
Axial Live Load	=	0.0 lbs
Axial Load Eccentricity	=	0.0 in

Earth Pressure Seismic Load

Method : Uniform		
Multiplier Used	=	8.000
(Multiplier used on soil density)		
Uniform Seismic Force	=	48.000
Total Seismic Force	=	288.000

Design Summary

Wall Stability Ratios		
Overturning	=	2.00 OK
Sliding	=	1.59 OK
Total Bearing Load	=	1,978 lbs
...resultant ecc.	=	7.74 in
Soil Pressure @ Toe	=	1,402 psf OK
Soil Pressure @ Heel	=	0 psf OK
Allowable	=	1,995 psf
Soil Pressure Less Than Allowable		
ACI Factored @ Toe	=	1,963 psf
ACI Factored @ Heel	=	0 psf
Footing Shear @ Toe	=	3.8 psi OK
Footing Shear @ Heel	=	7.8 psi OK
Allowable	=	75.0 psi
Sliding Calcs		
Lateral Sliding Force	=	831.6 lbs
less 100% Passive Force	=	- 281.3 lbs
less 100% Friction Force	=	- 1,038.2 lbs
Added Force Req'd	=	0.0 lbs OK
....for 1.5 Stability	=	0.0 lbs OK

Stem Construction

	3rd	2nd	Bottom
Design Height Above Ftg	ft = 4.33	ft = 3.33	ft = 0.00
Wall Material Above "Ht"	Concrete	Concrete	Concrete
Design Method	LRFD	LRFD	LRFD
Thickness	= 8.00	= 8.00	= 8.00
Rebar Size	= # 4	= # 4	= # 4
Rebar Spacing	= 12.00	= 12.00	= 12.00
Rebar Placed at	= Edge	= Edge	= Edge

Design Data

fb/FB + fa/Fa	=	0.002	0.020	0.325
Total Force @ Section				
Service Level	lbs =			
Strength Level	lbs =	44.7	158.2	940.0
Moment....Actual				
Service Level	ft-# =			
Strength Level	ft-# =	13.6	110.4	1,766.7
Moment....Allowable	ft-# =	5,359.5	5,359.5	5,412.6
Shear.....Actual				
Service Level	psi =			
Strength Level	psi =	0.6	2.1	12.5
Shear.....Allowable	psi =	67.1	67.1	75.0
Anet (Masonry)	in2 =			
Rebar Depth 'd'	in =	6.25	6.25	6.25

Masonry Data

f'm	psi =			
Fs	psi =			
Solid Grouting	=			
Modular Ratio 'n'	=			
Wall Weight	psf =	100.0	100.0	100.0
Short Term Factor	=			
Equiv. Solid Thick.	=			
Masonry Block Type	=	Medium Weight		
Masonry Design Method	=	ASD		

Concrete Data

fc	psi =	2,000.0	2,000.0	2,500.0
Fy	psi =	60,000.0	60,000.0	60,000.0

Vertical component of active lateral soil pressure IS NOT considered in the calculation of soil bearing

Load Factors

Building Code	IBC 2015,ACI
Dead Load	1.200
Live Load	1.600
Earth, H	1.600
Wind, W	1.000
Seismic, E	1.000

This Wall in File:

Enercalc EARTH (c) 1987-2019, Build 11.19.06.12
 License : KW-06011484
 License To : CKS, KW-06011484

Cantilevered Retaining Wall

Code: IBC 2015,ACI 318-14,ACI 530-13

Concrete Stem Rebar Area Details

3rd Stem	Vertical Reinforcing	Horizontal Reinforcing	
As (based on applied moment) :	0.0005 in2/ft		
(4/3) * As :	0.0007 in2/ft	Min Stem T&S Reinf Area 0.129 in2	
200bd/fy : 200(12)(6.25)/60000 :	0.25 in2/ft	Min Stem T&S Reinf Area per ft of stem Height : 0.192 in2/ft	
0.0018bh : 0.0018(12)(8) :	0.1728 in2/ft	Horizontal Reinforcing Options :	
	=====	One layer of :	Two layers of :
Required Area :	0.1728 in2/ft	#4@ 12.50 in	#4@ 25.00 in
Provided Area :	0.2 in2/ft	#5@ 19.38 in	#5@ 38.75 in
Maximum Area :	0.6773 in2/ft	#6@ 27.50 in	#6@ 55.00 in

2nd Stem	Vertical Reinforcing	Horizontal Reinforcing	
As (based on applied moment) :	0.0041 in2/ft		
(4/3) * As :	0.0055 in2/ft	Min Stem T&S Reinf Area 0.192 in2	
200bd/fy : 200(12)(6.25)/60000 :	0.25 in2/ft	Min Stem T&S Reinf Area per ft of stem Height : 0.192 in2/ft	
0.0018bh : 0.0018(12)(8) :	0.1728 in2/ft	Horizontal Reinforcing Options :	
	=====	One layer of :	Two layers of :
Required Area :	0.1728 in2/ft	#4@ 12.50 in	#4@ 25.00 in
Provided Area :	0.2 in2/ft	#5@ 19.38 in	#5@ 38.75 in
Maximum Area :	0.6773 in2/ft	#6@ 27.50 in	#6@ 55.00 in

Bottom Stem	Vertical Reinforcing	Horizontal Reinforcing	
As (based on applied moment) :	0.0662 in2/ft		
(4/3) * As :	0.0883 in2/ft	Min Stem T&S Reinf Area 0.639 in2	
200bd/fy : 200(12)(6.25)/60000 :	0.25 in2/ft	Min Stem T&S Reinf Area per ft of stem Height : 0.192 in2/ft	
0.0018bh : 0.0018(12)(8) :	0.1728 in2/ft	Horizontal Reinforcing Options :	
	=====	One layer of :	Two layers of :
Required Area :	0.1728 in2/ft	#4@ 12.50 in	#4@ 25.00 in
Provided Area :	0.2 in2/ft	#5@ 19.38 in	#5@ 38.75 in
Maximum Area :	0.8467 in2/ft	#6@ 27.50 in	#6@ 55.00 in

Footing Data

Toe Width	=	1.00 ft
Heel Width	=	2.17
Total Footing Width	=	3.17
Footing Thickness	=	12.00 in
Key Width	=	0.00 in
Key Depth	=	0.00 in
Key Distance from Toe	=	0.00 ft
f _c =	2,500 psi	F _y = 60,000 psi
Footing Concrete Density	=	150.00 pcf
Min. As %	=	0.0018
Cover @ Top	2.00	@ Btm = 3.00 in

Footing Design Results

		Toe	Heel
Factored Pressure	=	1,963	0 psf
Mu' : Upward	=	10,388	2,137 ft-#
Mu' : Downward	=	1,530	12,611 ft-#
Mu: Design	=	309	64 ft-#
Actual 1-Way Shear	=	3.84	7.79 psi
Allow 1-Way Shear	=	40.00	40.00 psi
Toe Reinforcing	=	None Spec'd	
Heel Reinforcing	=	None Spec'd	
Key Reinforcing	=	None Spec'd	
Footing Torsion, Tu	=	0.00 ft-lbs	
Footing Allow. Torsion, phi Tu	=	0.00 ft-lbs	

If torsion exceeds allowable, provide supplemental design for footing torsion.

Other Acceptable Sizes & Spacings

Toe: Not req'd: $Mu < \phi * 5 * \lambda * \sqrt{f_c} * S_m$
 Heel: Not req'd: $Mu < \phi * 5 * \lambda * \sqrt{f_c} * S_m$
 Key: No key defined

Min footing T&S reinf Area	0.82	in2
Min footing T&S reinf Area per foot	0.26	in2 /ft
If one layer of horizontal bars:	If two layers of horizontal bars:	
#4@ 9.26 in	#4@ 18.52 in	
#5@ 14.35 in	#5@ 28.70 in	
#6@ 20.37 in	#6@ 40.74 in	

This Wall in File:

Enercalc EARTH (c) 1987-2019, Build 11.19.06.12
 License : KW-06011484
 License To : CKS, KW-06011484

Cantilevered Retaining Wall

Code: IBC 2015,ACI 318-14,ACI 530-13

Summary of Overturning & Resisting Forces & Moments

ItemOVERTURNING.....		RESISTING.....			
	Force lbs	Distance ft	Moment ft-#	Force lbs	Distance ft	Moment ft-#	
HL Act Pres (ab water tbl)	630.0	2.00	1,260.0	Soil Over HL (ab. water tbl)	939.6	2.42	2,272.2
HL Act Pres (be water tbl)				Soil Over HL (bel. water tbl)		2.42	2,272.2
Hydrostatic Force				Watre Table			
Buoyant Force =				Sloped Soil Over Heel =			
Surcharge over Heel =				Surcharge Over Heel =			
Surcharge Over Toe =				Adjacent Footing Load =			
Adjacent Footing Load =				Axial Dead Load on Stem =			
Added Lateral Load =				* Axial Live Load on Stem =			
Load @ Stem Above Soil =				Soil Over Toe =	62.5	0.50	31.3
Seismic Earth Load =	201.6	3.00	604.8	Surcharge Over Toe =			
=				Stem Weight(s) =	500.0	1.33	666.7
Total =	831.6	O.T.M. =	1,864.8	Earth @ Stem Transitions =			
				Footing Weight =	475.5	1.59	753.7
				Key Weight =			
				Vert. Component =			
Resisting/Overturning Ratio =			2.00	Total =	1,977.6 lbs	R.M.=	3,723.8
Vertical Loads used for Soil Pressure =		1,977.6 lbs					

* Axial live load NOT included in total displayed, or used for overturning resistance, but is included for soil pressure calculation.

If seismic is included, the OTM and sliding ratios be 1.1 per section 1807.2.3 of IBC 2009 or IBC 201

Vertical component of active lateral soil pressure IS NOT considered in the calculation of Sliding Resistance.

Vertical component of active lateral soil pressure IS NOT considered in the calculation of Overturning Resistance.

Tilt

Horizontal Deflection at Top of Wall due to settlement of soil

(Deflection due to wall bending not considered)

Soil Spring Reaction Modulus 250.0 pci
 Horizontal Defl @ Top of Wall (approximate only) 0.000 in

The above calculation is not valid if the heel soil bearing pressure exceeds that of the toe, because the wall would then tend to rotate into the retained soil.

This Wall in File:

Enercalc EARTH (c) 1987-2019, Build 11.19.06.12
License : KW-06011484
License To : CKS, KW-06011484

Cantilevered Retaining Wall

Code: IBC 2015,ACI 318-14,ACI 530-13

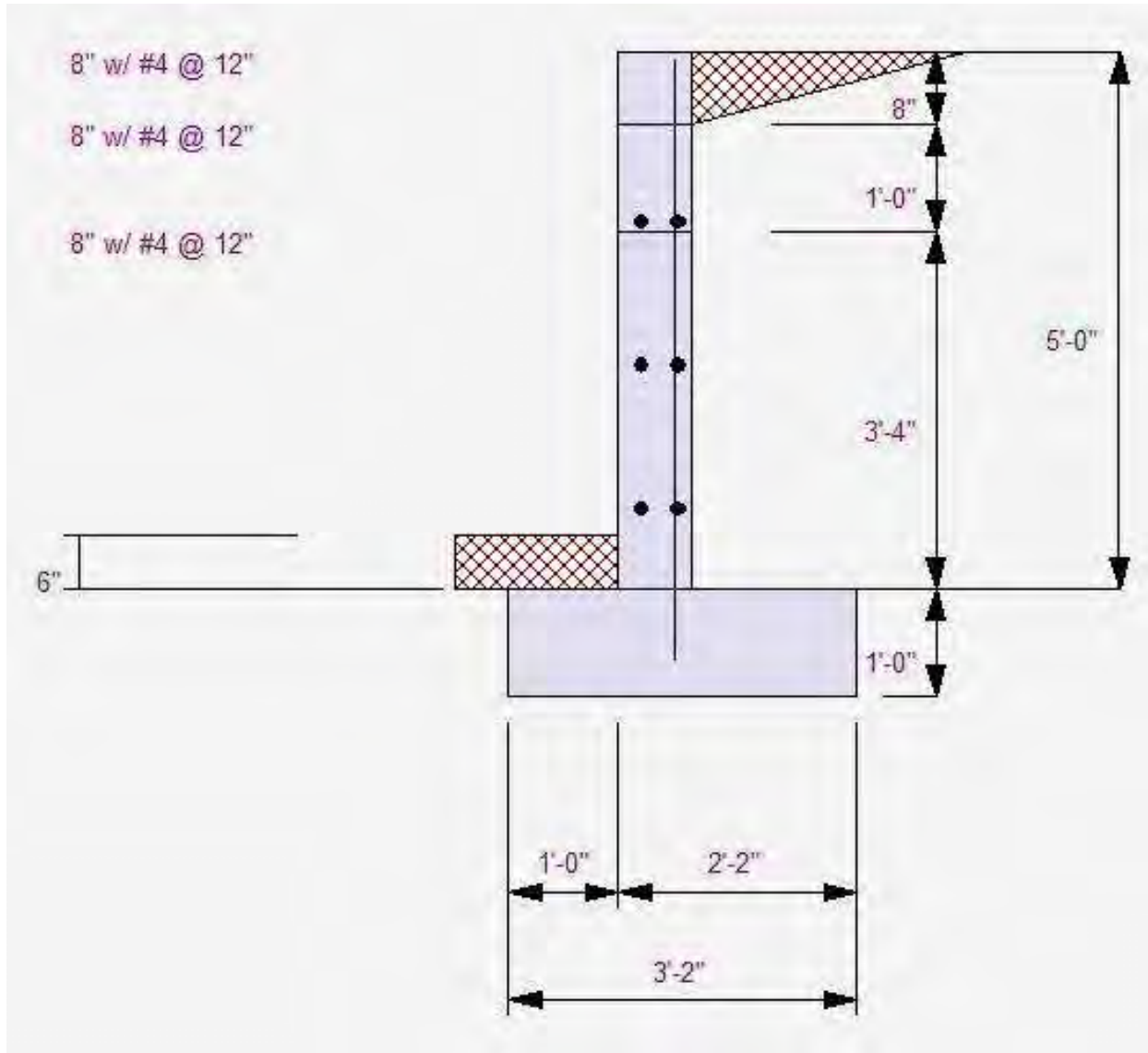

This Wall in File:

Enercalc EARTH (c) 1987-2019, Build 11.19.06.12
 License : KW-06011484
 License To : CKS, KW-06011484

Cantilevered Retaining Wall

Code: IBC 2015,ACI 318-14,ACI 530-13

Criteria

Retained Height	=	6.00 ft
Wall height above soil	=	0.00 ft
Slope Behind Wall	=	0.00
Height of Soil over Toe	=	6.00 in
Water height over heel	=	0.0 ft

Soil Data

Allow Soil Bearing	=	1,995.0 psf
Equivalent Fluid Pressure Method		
Active Heel Pressure	=	35.0 psf/ft
Passive Pressure	=	450.0 psf/ft
Soil Density, Heel	=	125.00 pcf
Soil Density, Toe	=	125.00 pcf
Footing Soil Friction	=	0.525
Soil height to ignore for passive pressure	=	12.00 in

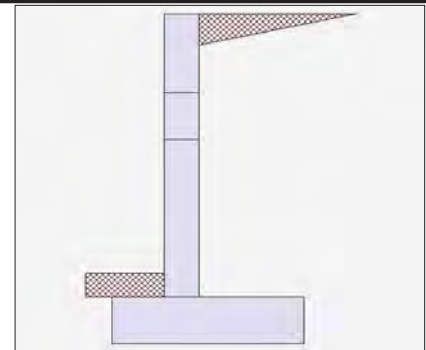

Surcharge Loads

Surcharge Over Heel	=	0.0 psf
Used To Resist Sliding & Overturning		
Surcharge Over Toe	=	0.0 psf
Used for Sliding & Overturning		

Lateral Load Applied to Stem

Lateral Load	=	0.0 #/ft
...Height to Top	=	0.00 ft
...Height to Bottom	=	0.00 ft
Load Type	=	Wind (W) (Service Level)
Wind on Exposed Stem	=	0.0 psf (Service Level)

Adjacent Footing Load

Adjacent Footing Load	=	0.0 lbs
Footing Width	=	0.00 ft
Eccentricity	=	0.00 in
Wall to Ftg CL Dist	=	0.00 ft
Footing Type	=	Line Load
Base Above/Below Soil at Back of Wall	=	0.0 ft
Poisson's Ratio	=	0.300

Axial Load Applied to Stem

Axial Dead Load	=	0.0 lbs
Axial Live Load	=	0.0 lbs
Axial Load Eccentricity	=	0.0 in

Earth Pressure Seismic Load

Method : Uniform			Uniform Seismic Force	=	56.000
Multiplier Used	=	8.000	Total Seismic Force	=	392.000
(Multiplier used on soil density)					

Design Summary

Wall Stability Ratios		
Overturning	=	1.98 OK
Sliding	=	1.51 OK
Total Bearing Load	=	2,716 lbs
...resultant ecc.	=	9.25 in
Soil Pressure @ Toe	=	1,701 psf OK
Soil Pressure @ Heel	=	0 psf OK
Allowable	=	1,995 psf
Soil Pressure Less Than Allowable		
ACI Factored @ Toe	=	2,382 psf
ACI Factored @ Heel	=	0 psf
Footing Shear @ Toe	=	4.8 psi OK
Footing Shear @ Heel	=	10.8 psi OK
Allowable	=	75.0 psi
Sliding Calcs		
Lateral Sliding Force	=	1,131.9 lbs
less 100% Passive Force	=	- 281.3 lbs
less 100% Friction Force	=	- 1,425.6 lbs
Added Force Req'd	=	0.0 lbs OK
....for 1.5 Stability	=	0.0 lbs OK

Stem Construction

	3rd	2nd	Bottom
Design Height Above Ftg	ft = 4.33	ft = 3.33	ft = 0.00
Wall Material Above "Ht"	Concrete	Concrete	Concrete
Design Method	LRFD	LRFD	LRFD
Thickness	= 8.00	= 8.00	= 8.00
Rebar Size	= # 4	= # 4	= # 4
Rebar Spacing	= 12.00	= 12.00	= 12.00
Rebar Placed at	= Edge	= Edge	= Edge

Design Data

fb/FB + fa/Fa	=	0.022	0.069	0.558
Total Force @ Section				
Service Level	lbs =			
Strength Level	lbs =	171.6	349.1	1,344.0
Moment....Actual				
Service Level	ft-# =			
Strength Level	ft-# =	121.6	377.3	3,024.0
Moment....Allowable	ft-# =	5,359.5	5,359.5	5,412.6
Shear.....Actual				
Service Level	psi =			
Strength Level	psi =	2.3	4.7	17.9
Shear.....Allowable	psi =	67.1	67.1	75.0
Anet (Masonry)	in2 =			
Rebar Depth 'd'	in =	6.25	6.25	6.25

Masonry Data

f'm	psi =			
Fs	psi =			
Solid Grouting	=			
Modular Ratio 'n'	=			
Wall Weight	psf =	100.0	100.0	100.0
Short Term Factor	=			
Equiv. Solid Thick.	=			
Masonry Block Type	=	Medium Weight		
Masonry Design Method	=	ASD		

Concrete Data

fc	psi =	2,000.0	2,000.0	2,500.0
Fy	psi =	60,000.0	60,000.0	60,000.0

Vertical component of active lateral soil pressure IS NOT considered in the calculation of soil bearing

Load Factors

Building Code	IBC 2015,ACI
Dead Load	1.200
Live Load	1.600
Earth, H	1.600
Wind, W	1.000
Seismic, E	1.000

This Wall in File:

Enercalc EARTH (c) 1987-2019, Build 11.19.06.12
 License : KW-06011484
 License To : CKS, KW-06011484

Cantilevered Retaining Wall

Code: IBC 2015,ACI 318-14,ACI 530-13

Concrete Stem Rebar Area Details

3rd Stem	Vertical Reinforcing	Horizontal Reinforcing	
As (based on applied moment) :	0.0046 in2/ft		
(4/3) * As :	0.0061 in2/ft	Min Stem T&S Reinf Area 0.321 in2	
200bd/fy : 200(12)(6.25)/60000 :	0.25 in2/ft	Min Stem T&S Reinf Area per ft of stem Height : 0.192 in2/ft	
0.0018bh : 0.0018(12)(8) :	0.1728 in2/ft	Horizontal Reinforcing Options :	
	=====	One layer of :	Two layers of :
Required Area :	0.1728 in2/ft	#4@ 12.50 in	#4@ 25.00 in
Provided Area :	0.2 in2/ft	#5@ 19.38 in	#5@ 38.75 in
Maximum Area :	0.6773 in2/ft	#6@ 27.50 in	#6@ 55.00 in

2nd Stem	Vertical Reinforcing	Horizontal Reinforcing	
As (based on applied moment) :	0.0141 in2/ft		
(4/3) * As :	0.0188 in2/ft	Min Stem T&S Reinf Area 0.192 in2	
200bd/fy : 200(12)(6.25)/60000 :	0.25 in2/ft	Min Stem T&S Reinf Area per ft of stem Height : 0.192 in2/ft	
0.0018bh : 0.0018(12)(8) :	0.1728 in2/ft	Horizontal Reinforcing Options :	
	=====	One layer of :	Two layers of :
Required Area :	0.1728 in2/ft	#4@ 12.50 in	#4@ 25.00 in
Provided Area :	0.2 in2/ft	#5@ 19.38 in	#5@ 38.75 in
Maximum Area :	0.6773 in2/ft	#6@ 27.50 in	#6@ 55.00 in

Bottom Stem	Vertical Reinforcing	Horizontal Reinforcing	
As (based on applied moment) :	0.1133 in2/ft		
(4/3) * As :	0.1511 in2/ft	Min Stem T&S Reinf Area 0.639 in2	
200bd/fy : 200(12)(6.25)/60000 :	0.25 in2/ft	Min Stem T&S Reinf Area per ft of stem Height : 0.192 in2/ft	
0.0018bh : 0.0018(12)(8) :	0.1728 in2/ft	Horizontal Reinforcing Options :	
	=====	One layer of :	Two layers of :
Required Area :	0.1728 in2/ft	#4@ 12.50 in	#4@ 25.00 in
Provided Area :	0.2 in2/ft	#5@ 19.38 in	#5@ 38.75 in
Maximum Area :	0.8467 in2/ft	#6@ 27.50 in	#6@ 55.00 in

Footing Data

Toe Width	=	1.00 ft
Heel Width	=	2.67
Total Footing Width	=	3.67
Footing Thickness	=	12.00 in
Key Width	=	0.00 in
Key Depth	=	0.00 in
Key Distance from Toe	=	0.00 ft
f _c =	2,500 psi	F _y = 60,000 psi
Footing Concrete Density	=	150.00 pcf
Min. As %	=	0.0018
Cover @ Top	2.00	@ Btm = 3.00 in

Footing Design Results

		<u>Toe</u>	<u>Heel</u>
Factored Pressure	=	2,382	0 psf
Mu' : Upward	=	12,799	5,297 ft-#
Mu' : Downward	=	1,530	26,006 ft-#
Mu: Design	=	390	89 ft-#
Actual 1-Way Shear	=	4.84	10.80 psi
Allow 1-Way Shear	=	40.00	40.00 psi
Toe Reinforcing	=	None Spec'd	
Heel Reinforcing	=	None Spec'd	
Key Reinforcing	=	None Spec'd	
Footing Torsion, Tu	=	0.00 ft-lbs	
Footing Allow. Torsion, phi Tu	=	0.00 ft-lbs	

If torsion exceeds allowable, provide supplemental design for footing torsion.

Other Acceptable Sizes & Spacings

Toe: Not req'd: $Mu < \phi * 5 * \lambda * \sqrt{f_c} * S_m$
 Heel: Not req'd: $Mu < \phi * 5 * \lambda * \sqrt{f_c} * S_m$
 Key: No key defined

Min footing T&S reinf Area	0.95	in2
Min footing T&S reinf Area per foot	0.26	in2 /ft
If one layer of horizontal bars:	If two layers of horizontal bars:	
#4@ 9.26 in	#4@ 18.52 in	
#5@ 14.35 in	#5@ 28.70 in	
#6@ 20.37 in	#6@ 40.74 in	

This Wall in File:

Enercalc EARTH (c) 1987-2019, Build 11.19.06.12
 License : KW-06011484
 License To : CKS, KW-06011484

Cantilevered Retaining Wall

Code: IBC 2015,ACI 318-14,ACI 530-13

Summary of Overturning & Resisting Forces & Moments

ItemOVERTURNING.....		RESISTING.....			
	Force lbs	Distance ft	Moment ft-#	Force lbs	Distance ft	Moment ft-#	
HL Act Pres (ab water tbl)	857.5	2.33	2,000.8	Soil Over HL (ab. water tbl)	1,502.5	2.67	4,009.2
HL Act Pres (be water tbl)				Soil Over HL (bel. water tbl)		2.67	4,009.2
Hydrostatic Force				Watre Table			
Buoyant Force =				Sloped Soil Over Heel =			
Surcharge over Heel =				Surcharge Over Heel =			
Surcharge Over Toe =				Adjacent Footing Load =			
Adjacent Footing Load =				Axial Dead Load on Stem =			
Added Lateral Load =				* Axial Live Load on Stem =			
Load @ Stem Above Soil =				Soil Over Toe =	62.5	0.50	31.3
Seismic Earth Load =	274.4	3.50	960.4	Surcharge Over Toe =			
=				Stem Weight(s) =	600.0	1.33	800.0
Total =	1,131.9	O.T.M. =	2,961.2	Earth @ Stem Transitions =			
				Footing Weight =	550.5	1.84	1,010.2
				Key Weight =			
				Vert. Component =			
Resisting/Overturning Ratio =			1.98	Total =	2,715.5 lbs	R.M.=	5,850.6
Vertical Loads used for Soil Pressure =		2,715.5 lbs					

* Axial live load NOT included in total displayed, or used for overturning resistance, but is included for soil pressure calculation.

If seismic is included, the OTM and sliding ratios be 1.1 per section 1807.2.3 of IBC 2009 or IBC 201

Vertical component of active lateral soil pressure IS NOT considered in the calculation of Sliding Resistance.

Vertical component of active lateral soil pressure IS NOT considered in the calculation of Overturning Resistance.

Tilt

Horizontal Deflection at Top of Wall due to settlement of soil

(Deflection due to wall bending not considered)

Soil Spring Reaction Modulus 250.0 pci
 Horizontal Defl @ Top of Wall (approximate only) 0.000 in

The above calculation is not valid if the heel soil bearing pressure exceeds that of the toe, because the wall would then tend to rotate into the retained soil.

This Wall in File:

Enercalc EARTH (c) 1987-2019, Build 11.19.06.12
License : KW-06011484
License To : CKS, KW-06011484

Cantilevered Retaining Wall

Code: IBC 2015,ACI 318-14,ACI 530-13

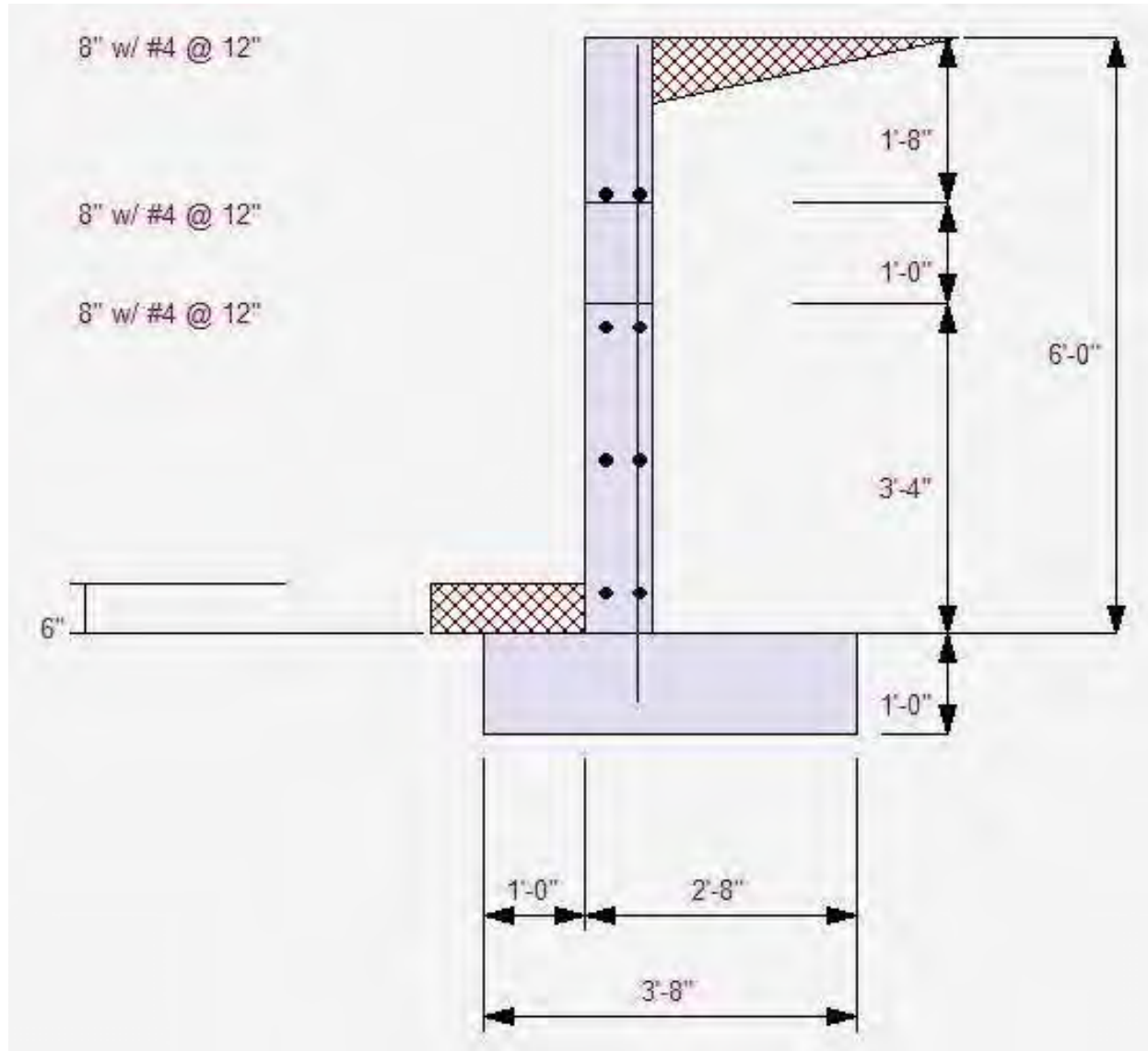

This Wall in File:

Enercalc EARTH (c) 1987-2019, Build 11.19.06.12
 License : KW-06011484
 License To : CKS, KW-06011484

Cantilevered Retaining Wall

Code: IBC 2015,ACI 318-14,ACI 530-13

Criteria

Retained Height	=	7.00 ft
Wall height above soil	=	0.00 ft
Slope Behind Wall	=	0.00
Height of Soil over Toe	=	6.00 in
Water height over heel	=	0.0 ft

Soil Data

Allow Soil Bearing	=	1,995.0 psf
Equivalent Fluid Pressure Method		
Active Heel Pressure	=	35.0 psf/ft
Passive Pressure	=	450.0 psf/ft
Soil Density, Heel	=	125.00 pcf
Soil Density, Toe	=	125.00 pcf
Footing Soil Friction	=	0.525
Soil height to ignore for passive pressure	=	12.00 in

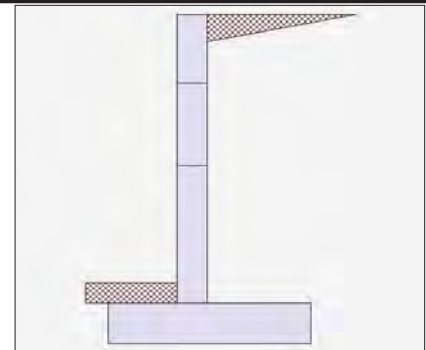

Surcharge Loads

Surcharge Over Heel	=	0.0 psf
Used To Resist Sliding & Overturning		
Surcharge Over Toe	=	0.0 psf
Used for Sliding & Overturning		

Lateral Load Applied to Stem

Lateral Load	=	0.0 #/ft
...Height to Top	=	0.00 ft
...Height to Bottom	=	0.00 ft
Load Type	=	Wind (W) (Service Level)
Wind on Exposed Stem	=	0.0 psf (Service Level)

Adjacent Footing Load

Adjacent Footing Load	=	0.0 lbs
Footing Width	=	0.00 ft
Eccentricity	=	0.00 in
Wall to Ftg CL Dist	=	0.00 ft
Footing Type	=	Line Load
Base Above/Below Soil at Back of Wall	=	0.0 ft
Poisson's Ratio	=	0.300

Axial Load Applied to Stem

Axial Dead Load	=	0.0 lbs
Axial Live Load	=	0.0 lbs
Axial Load Eccentricity	=	0.0 in

Earth Pressure Seismic Load

Method : Uniform			Uniform Seismic Force	=	64.000
Multiplier Used	=	8.000	Total Seismic Force	=	512.000
(Multiplier used on soil density)					

Design Summary

Wall Stability Ratios		
Overturning	=	2.11 OK
Sliding	=	1.41 Ratio < 1.5!
Total Bearing Load	=	3,428 lbs
...resultant ecc.	=	9.40 in
Soil Pressure @ Toe	=	1,602 psf OK
Soil Pressure @ Heel	=	0 psf OK
Allowable	=	1,995 psf
Soil Pressure Less Than Allowable		
ACI Factored @ Toe	=	2,243 psf
ACI Factored @ Heel	=	0 psf
Footing Shear @ Toe	=	11.6 psi OK
Footing Shear @ Heel	=	13.3 psi OK
Allowable	=	75.0 psi
Sliding Calcs		
Lateral Sliding Force	=	1,478.4 lbs
less 100% Passive Force	=	- 281.3 lbs
less 100% Friction Force	=	- 1,799.9 lbs
Added Force Req'd	=	0.0 lbs OK
....for 1.5 Stability	=	136.4 lbs NG

Stem Construction

	3rd	2nd	Bottom	
Design Height Above Ftg	ft = 5.33	3.33	0.00	
Wall Material Above "Ht"	Concrete	Concrete	Concrete	
Design Method	LRFD	LRFD	LRFD	
Thickness	= 8.00	8.00	8.00	
Rebar Size	= # 4	# 4	# 4	
Rebar Spacing	= 10.00	10.00	10.00	
Rebar Placed at	= Edge	Edge	Edge	
Design Data				
fb/FB + fa/Fa	= 0.020	0.139	0.739	
Total Force @ Section				
Service Level	lbs =			
Strength Level	lbs =	185.0	612.0	1,820.0
Moment....Actual				
Service Level	ft-# =			
Strength Level	ft-# =	132.7	892.4	4,769.3
Moment.....Allowable	ft-# =	6,367.7	6,367.7	6,444.1
Shear.....Actual				
Service Level	psi =			
Strength Level	psi =	2.5	8.2	24.3
Shear.....Allowable	psi =	67.1	67.1	75.0
Anet (Masonry)	in2 =			
Rebar Depth 'd'	in =	6.25	6.25	6.25
Masonry Data				
f'm	psi =			
Fs	psi =			
Solid Grouting	=			
Modular Ratio 'n'	=			
Wall Weight	psf =	100.0	100.0	100.0
Short Term Factor	=			
Equiv. Solid Thick.	=			
Masonry Block Type	=	Medium Weight		
Masonry Design Method	=	ASD		
Concrete Data				
fc	psi =	2,000.0	2,000.0	2,500.0
Fy	psi =	60,000.0	60,000.0	60,000.0

OK, FS > 1.1

Vertical component of active lateral soil pressure IS NOT considered in the calculation of soil bearing

Load Factors

Building Code	IBC 2015,ACI
Dead Load	1.200
Live Load	1.600
Earth, H	1.600
Wind, W	1.000
Seismic, E	1.000

This Wall in File:

Enercalc EARTH (c) 1987-2019, Build 11.19.06.12
 License : KW-06011484
 License To : CKS, KW-06011484

Cantilevered Retaining Wall

Code: IBC 2015,ACI 318-14,ACI 530-13

Concrete Stem Rebar Area Details

3rd Stem	Vertical Reinforcing	Horizontal Reinforcing	
As (based on applied moment) :	0.005 in2/ft		
(4/3) * As :	0.0066 in2/ft	Min Stem T&S Reinf Area 0.321 in2	
200bd/fy : 200(12)(6.25)/60000 :	0.25 in2/ft	Min Stem T&S Reinf Area per ft of stem Height : 0.192 in2/ft	
0.0018bh : 0.0018(12)(8) :	0.1728 in2/ft	Horizontal Reinforcing Options :	
	=====	One layer of :	Two layers of :
Required Area :	0.1728 in2/ft	#4@ 12.50 in	#4@ 25.00 in
Provided Area :	0.24 in2/ft	#5@ 19.38 in	#5@ 38.75 in
Maximum Area :	0.6773 in2/ft	#6@ 27.50 in	#6@ 55.00 in

2nd Stem	Vertical Reinforcing	Horizontal Reinforcing	
As (based on applied moment) :	0.0334 in2/ft		
(4/3) * As :	0.0446 in2/ft	Min Stem T&S Reinf Area 0.384 in2	
200bd/fy : 200(12)(6.25)/60000 :	0.25 in2/ft	Min Stem T&S Reinf Area per ft of stem Height : 0.192 in2/ft	
0.0018bh : 0.0018(12)(8) :	0.1728 in2/ft	Horizontal Reinforcing Options :	
	=====	One layer of :	Two layers of :
Required Area :	0.1728 in2/ft	#4@ 12.50 in	#4@ 25.00 in
Provided Area :	0.24 in2/ft	#5@ 19.38 in	#5@ 38.75 in
Maximum Area :	0.6773 in2/ft	#6@ 27.50 in	#6@ 55.00 in

Bottom Stem	Vertical Reinforcing	Horizontal Reinforcing	
As (based on applied moment) :	0.1787 in2/ft		
(4/3) * As :	0.2383 in2/ft	Min Stem T&S Reinf Area 0.639 in2	
200bd/fy : 200(12)(6.25)/60000 :	0.25 in2/ft	Min Stem T&S Reinf Area per ft of stem Height : 0.192 in2/ft	
0.0018bh : 0.0018(12)(8) :	0.1728 in2/ft	Horizontal Reinforcing Options :	
	=====	One layer of :	Two layers of :
Required Area :	0.2383 in2/ft	#4@ 12.50 in	#4@ 25.00 in
Provided Area :	0.24 in2/ft	#5@ 19.38 in	#5@ 38.75 in
Maximum Area :	0.8467 in2/ft	#6@ 27.50 in	#6@ 55.00 in

Footing Data

Toe Width	=	1.50 ft
Heel Width	=	2.92
Total Footing Width	=	4.42
Footing Thickness	=	12.00 in
Key Width	=	0.00 in
Key Depth	=	0.00 in
Key Distance from Toe	=	0.00 ft
f _c =	2,500 psi	F _y = 60,000 psi
Footing Concrete Density	=	150.00 pcf
Min. As %	=	0.0018
Cover @ Top	2.00	@ Btm = 3.00 in

Footing Design Results

		<u>Toe</u>	<u>Heel</u>
Factored Pressure	=	2,243	0 psf
Mu' : Upward	=	26,738	9,899 ft-#
Mu' : Downward	=	3,443	37,472 ft-#
Mu: Design	=	935	366 ft-#
Actual 1-Way Shear	=	11.58	13.34 psi
Allow 1-Way Shear	=	40.00	40.00 psi
Toe Reinforcing	=	None Spec'd	
Heel Reinforcing	=	None Spec'd	
Key Reinforcing	=	None Spec'd	
Footing Torsion, Tu	=	0.00 ft-lbs	
Footing Allow. Torsion, phi Tu	=	0.00 ft-lbs	

If torsion exceeds allowable, provide supplemental design for footing torsion.

Other Acceptable Sizes & Spacings

Toe: Not req'd: $Mu < \phi * 5 * \lambda * \sqrt{f_c} * S_m$
 Heel: Not req'd: $Mu < \phi * 5 * \lambda * \sqrt{f_c} * S_m$
 Key: No key defined

Min footing T&S reinf Area	1.15	in2
Min footing T&S reinf Area per foot	0.26	in2 /ft
If one layer of horizontal bars:	If two layers of horizontal bars:	
#4@ 9.26 in	#4@ 18.52 in	
#5@ 14.35 in	#5@ 28.70 in	
#6@ 20.37 in	#6@ 40.74 in	

This Wall in File:

Enercalc EARTH (c) 1987-2019, Build 11.19.06.12
 License : KW-06011484
 License To : CKS, KW-06011484

Cantilevered Retaining Wall

Code: IBC 2015,ACI 318-14,ACI 530-13

Summary of Overturning & Resisting Forces & Moments

ItemOVERTURNING.....		RESISTING.....			
	Force lbs	Distance ft	Moment ft-#	Force lbs	Distance ft	Moment ft-#	
HL Act Pres (ab water tbl)	1,120.0	2.67	2,986.7	Soil Over HL (ab. water tbl)	1,971.7	3.29	6,493.4
HL Act Pres (be water tbl)				Soil Over HL (bel. water tbl)		3.29	6,493.4
Hydrostatic Force				Watre Table			
Buoyant Force =				Sloped Soil Over Heel =			
Surcharge over Heel =				Surcharge Over Heel =			
Surcharge Over Toe =				Adjacent Footing Load =			
Adjacent Footing Load =				Axial Dead Load on Stem =			
Added Lateral Load =				* Axial Live Load on Stem =			
Load @ Stem Above Soil =				Soil Over Toe =	93.8	0.75	70.3
Seismic Earth Load =	358.4	4.00	1,433.6	Surcharge Over Toe =			
=				Stem Weight(s) =	700.0	1.83	1,283.3
Total =	1,478.4	O.T.M. =	4,420.3	Earth @ Stem Transitions =			
				Footing Weight =	663.0	2.21	1,465.2
				Key Weight =			
				Vert. Component =			
Resisting/Overturning Ratio		=	2.11	Total =	3,428.4 lbs	R.M.=	9,312.2
Vertical Loads used for Soil Pressure =		3,428.4 lbs					

* Axial live load NOT included in total displayed, or used for overturning resistance, but is included for soil pressure calculation.

If seismic is included, the OTM and sliding ratios be 1.1 per section 1807.2.3 of IBC 2009 or IBC 201

Vertical component of active lateral soil pressure IS NOT considered in the calculation of Sliding Resistance.

Vertical component of active lateral soil pressure IS NOT considered in the calculation of Overturning Resistance.

Tilt

Horizontal Deflection at Top of Wall due to settlement of soil

(Deflection due to wall bending not considered)

Soil Spring Reaction Modulus 250.0 pci
 Horizontal Defl @ Top of Wall (approximate only) 0.000 in

The above calculation is not valid if the heel soil bearing pressure exceeds that of the toe, because the wall would then tend to rotate into the retained soil.

This Wall in File:

Enercalc EARTH (c) 1987-2019, Build 11.19.06.12
License : KW-06011484
License To : CKS, KW-06011484

Cantilevered Retaining Wall

Code: IBC 2015,ACI 318-14,ACI 530-13

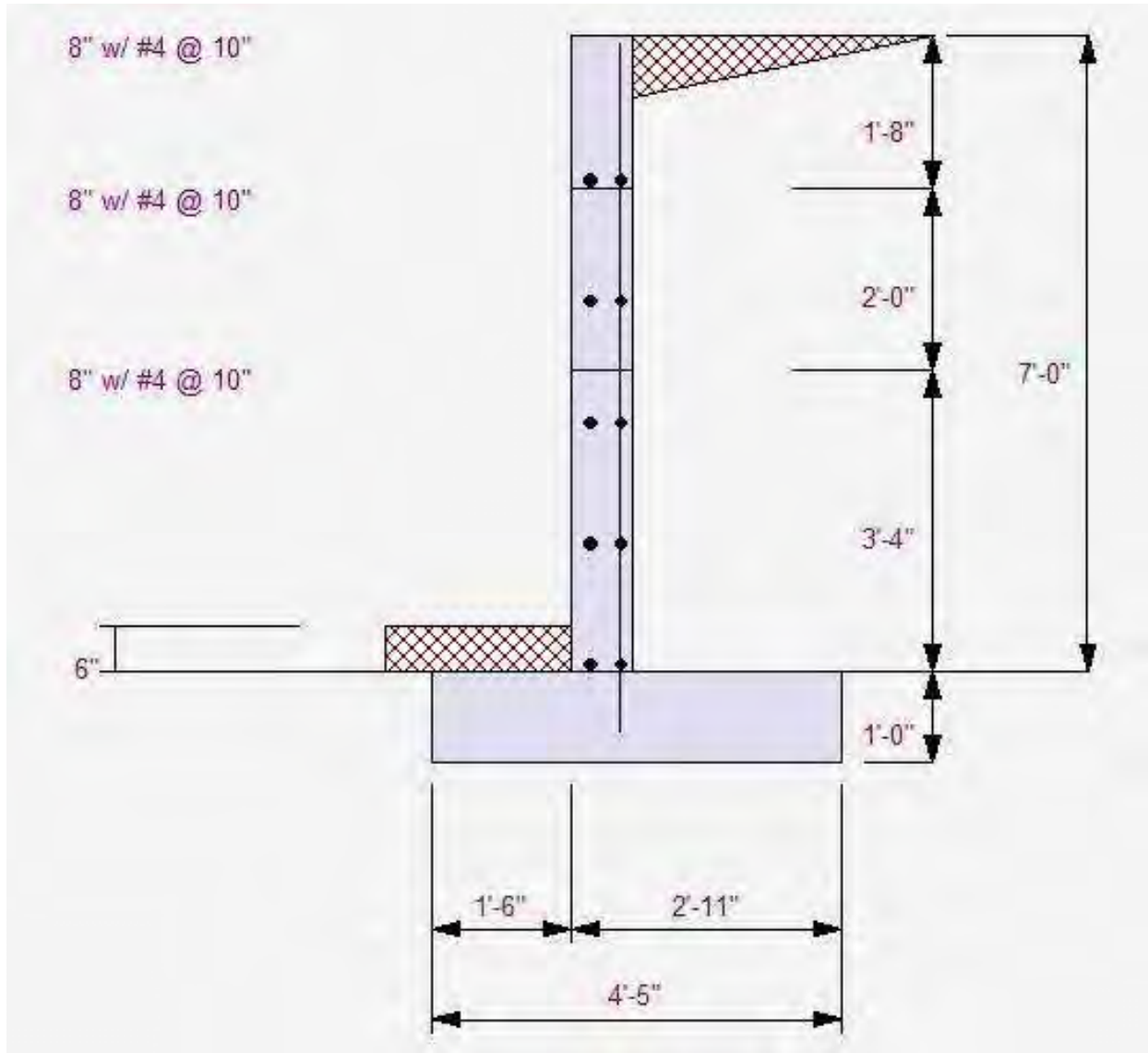

This Wall in File:

Enercalc EARTH (c) 1987-2019, Build 11.19.06.12
License : KW-06011484
License To : CKS, KW-06011484

Cantilevered Retaining Wall

Code: IBC 2015,ACI 318-14,ACI 530-13

Criteria

Retained Height	=	7.00 ft
Wall height above soil	=	0.00 ft
Slope Behind Wall	=	0.00
Height of Soil over Toe	=	6.00 in
Water height over heel	=	0.0 ft

Soil Data

Allow Soil Bearing	=	1,500.0 psf
Equivalent Fluid Pressure Method		
Active Heel Pressure	=	35.0 psf/ft
Passive Pressure	=	450.0 psf/ft
Soil Density, Heel	=	125.00 pcf
Soil Density, Toe	=	125.00 pcf
Footing Soil Friction	=	0.525
Soil height to ignore for passive pressure	=	12.00 in

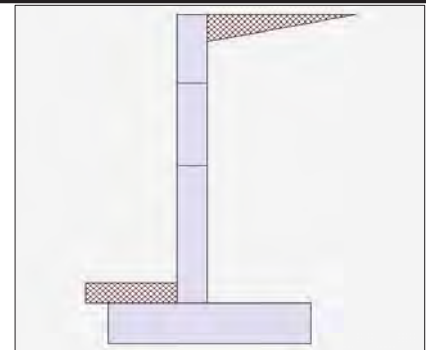

Surcharge Loads

Surcharge Over Heel	=	0.0 psf
Used To Resist Sliding & Overturning		
Surcharge Over Toe	=	0.0 psf
Used for Sliding & Overturning		

Lateral Load Applied to Stem

Lateral Load	=	0.0 #/ft
...Height to Top	=	0.00 ft
...Height to Bottom	=	0.00 ft
Load Type	=	Wind (W) (Service Level)
Wind on Exposed Stem	=	0.0 psf (Service Level)

Adjacent Footing Load

Adjacent Footing Load	=	0.0 lbs
Footing Width	=	0.00 ft
Eccentricity	=	0.00 in
Wall to Ftg CL Dist	=	0.00 ft
Footing Type		Line Load
Base Above/Below Soil at Back of Wall	=	0.0 ft
Poisson's Ratio	=	0.300

Axial Load Applied to Stem

Axial Dead Load	=	0.0 lbs
Axial Live Load	=	0.0 lbs
Axial Load Eccentricity	=	0.0 in

Design Summary

Wall Stability Ratios

Overturning	=	3.12 OK
Sliding	=	1.86 OK
Total Bearing Load	=	3,428 lbs
...resultant ecc.	=	4.38 in
Soil Pressure @ Toe	=	1,160 psf OK
Soil Pressure @ Heel	=	391 psf OK
Allowable	=	1,500 psf
Soil Pressure Less Than Allowable		
ACI Factored @ Toe	=	1,624 psf
ACI Factored @ Heel	=	548 psf
Footing Shear @ Toe	=	8.2 psi OK
Footing Shear @ Heel	=	7.7 psi OK
Allowable	=	75.0 psi

Sliding Calcs

Lateral Sliding Force	=	1,120.0 lbs
less 100% Passive Force	= -	281.3 lbs
less 100% Friction Force	= -	1,799.9 lbs
Added Force Req'd	=	0.0 lbs OK
....for 1.5 Stability	=	0.0 lbs OK

Stem Construction

Design Height Above Ftg

ft =	5.33	3.33	0.00	
Wall Material Above "Ht"	=	Concrete	Concrete	Concrete
Design Method	=	LRFD	LRFD	LRFD
Thickness	=	8.00	8.00	8.00
Rebar Size	=	# 4	# 4	# 4
Rebar Spacing	=	10.00	10.00	10.00
Rebar Placed at	=	Edge	Edge	Edge

Design Data

fb/FB + fa/Fa	=	0.006	0.071	0.496
---------------	---	-------	-------	-------

Total Force @ Section

Service Level	lbs =			
Strength Level	lbs =	78.1	377.1	1,372.0

Moment....Actual

Service Level	ft-# =			
Strength Level	ft-# =	43.5	461.4	3,201.3
Moment.....Allowable	ft-# =	6,367.7	6,367.7	6,444.1

Shear.....Actual

Service Level	psi =			
Strength Level	psi =	1.0	5.0	18.3
Shear.....Allowable	psi =	67.1	67.1	75.0

Anet (Masonry)

Rebar Depth 'd'	in =	6.25	6.25	6.25
-----------------	------	------	------	------

Masonry Data

f'm	psi =			
Fs	psi =			
Solid Grouting	=			
Modular Ratio 'n'	=			
Wall Weight	psf =	100.0	100.0	100.0
Short Term Factor	=			
Equiv. Solid Thick.	=			
Masonry Block Type	=	Medium Weight		
Masonry Design Method	=	ASD		

Concrete Data

f'c	psi =	2,000.0	2,000.0	2,500.0
Fy	psi =	60,000.0	60,000.0	60,000.0

Vertical component of active lateral soil pressure IS NOT considered in the calculation of soil bearing

Load Factors

Building Code	IBC 2015,ACI
Dead Load	1.200
Live Load	1.600
Earth, H	1.600
Wind, W	1.000
Seismic, E	1.000

This Wall in File:

Enercalc EARTH (c) 1987-2019, Build 11.19.06.12
License : KW-06011484
License To : CKS, KW-06011484

Cantilevered Retaining Wall

Code: IBC 2015,ACI 318-14,ACI 530-13

Concrete Stem Rebar Area Details

3rd Stem	Vertical Reinforcing	Horizontal Reinforcing	
As (based on applied moment) :	0.0016 in2/ft		
(4/3) * As :	0.0022 in2/ft	Min Stem T&S Reinf Area 0.321 in2	
200bd/fy : 200(12)(6.25)/60000 :	0.25 in2/ft	Min Stem T&S Reinf Area per ft of stem Height : 0.192 in2/ft	
0.0018bh : 0.0018(12)(8) :	0.1728 in2/ft	Horizontal Reinforcing Options :	
	=====	One layer of :	Two layers of :
Required Area :	0.1728 in2/ft	#4@ 12.50 in	#4@ 25.00 in
Provided Area :	0.24 in2/ft	#5@ 19.38 in	#5@ 38.75 in
Maximum Area :	0.6773 in2/ft	#6@ 27.50 in	#6@ 55.00 in

2nd Stem	Vertical Reinforcing	Horizontal Reinforcing	
As (based on applied moment) :	0.0173 in2/ft		
(4/3) * As :	0.023 in2/ft	Min Stem T&S Reinf Area 0.384 in2	
200bd/fy : 200(12)(6.25)/60000 :	0.25 in2/ft	Min Stem T&S Reinf Area per ft of stem Height : 0.192 in2/ft	
0.0018bh : 0.0018(12)(8) :	0.1728 in2/ft	Horizontal Reinforcing Options :	
	=====	One layer of :	Two layers of :
Required Area :	0.1728 in2/ft	#4@ 12.50 in	#4@ 25.00 in
Provided Area :	0.24 in2/ft	#5@ 19.38 in	#5@ 38.75 in
Maximum Area :	0.6773 in2/ft	#6@ 27.50 in	#6@ 55.00 in

Bottom Stem	Vertical Reinforcing	Horizontal Reinforcing	
As (based on applied moment) :	0.1199 in2/ft		
(4/3) * As :	0.1599 in2/ft	Min Stem T&S Reinf Area 0.639 in2	
200bd/fy : 200(12)(6.25)/60000 :	0.25 in2/ft	Min Stem T&S Reinf Area per ft of stem Height : 0.192 in2/ft	
0.0018bh : 0.0018(12)(8) :	0.1728 in2/ft	Horizontal Reinforcing Options :	
	=====	One layer of :	Two layers of :
Required Area :	0.1728 in2/ft	#4@ 12.50 in	#4@ 25.00 in
Provided Area :	0.24 in2/ft	#5@ 19.38 in	#5@ 38.75 in
Maximum Area :	0.8467 in2/ft	#6@ 27.50 in	#6@ 55.00 in

Footing Data

Toe Width	=	1.50 ft
Heel Width	=	2.92
Total Footing Width	=	4.42
Footing Thickness	=	12.00 in
Key Width	=	0.00 in
Key Depth	=	0.00 in
Key Distance from Toe	=	0.00 ft
f _c =	2,500 psi	F _y = 60,000 psi
Footing Concrete Density	=	150.00 pcf
Min. As %	=	0.0018
Cover @ Top	2.00	@ Btm = 3.00 in

Footing Design Results

		<u>Toe</u>	<u>Heel</u>
Factored Pressure	=	1,624	548 psf
Mu' : Upward	=	20,280	22,263 ft-#
Mu' : Downward	=	3,443	37,472 ft-#
Mu: Design	=	935	366 ft-#
Actual 1-Way Shear	=	8.23	7.66 psi
Allow 1-Way Shear	=	40.00	40.00 psi
Toe Reinforcing	=	None Spec'd	
Heel Reinforcing	=	None Spec'd	
Key Reinforcing	=	None Spec'd	
Footing Torsion, Tu	=	0.00 ft-lbs	
Footing Allow. Torsion, phi Tu	=	0.00 ft-lbs	

If torsion exceeds allowable, provide supplemental design for footing torsion.

Other Acceptable Sizes & Spacings

Toe: Not req'd: $Mu < \phi * 5 * \lambda * \sqrt{f_c} * S_m$
 Heel: Not req'd: $Mu < \phi * 5 * \lambda * \sqrt{f_c} * S_m$
 Key: No key defined

Min footing T&S reinf Area	1.15	in2
Min footing T&S reinf Area per foot	0.26	in2 /ft
If one layer of horizontal bars:	If two layers of horizontal bars:	
#4@ 9.26 in	#4@ 18.52 in	
#5@ 14.35 in	#5@ 28.70 in	
#6@ 20.37 in	#6@ 40.74 in	

This Wall in File:

Enercalc EARTH (c) 1987-2019, Build 11.19.06.12
 License : KW-06011484
 License To : CKS, KW-06011484

Cantilevered Retaining Wall

Code: IBC 2015,ACI 318-14,ACI 530-13

Summary of Overturning & Resisting Forces & Moments

ItemOVERTURNING.....		RESISTING.....			
	Force lbs	Distance ft	Moment ft-#	Force lbs	Distance ft	Moment ft-#	
HL Act Pres (ab water tbl)	1,120.0	2.67	2,986.7	Soil Over HL (ab. water tbl)	1,971.7	3.29	6,493.4
HL Act Pres (be water tbl)				Soil Over HL (bel. water tbl)		3.29	6,493.4
Hydrostatic Force				Watre Table			
Buoyant Force =				Sloped Soil Over Heel =			
Surcharge over Heel =				Surcharge Over Heel =			
Surcharge Over Toe =				Adjacent Footing Load =			
Adjacent Footing Load =				Axial Dead Load on Stem =			
Added Lateral Load =				* Axial Live Load on Stem =			
Load @ Stem Above Soil =				Soil Over Toe =	93.8	0.75	70.3
				Surcharge Over Toe =			
				Stem Weight(s) =	700.0	1.83	1,283.3
				Earth @ Stem Transitions =			
Total	= 1,120.0	O.T.M.	= 2,986.7	Footing Weight =	663.0	2.21	1,465.2
				Key Weight =			
				Vert. Component =			
Resisting/Overturning Ratio		=	3.12	Total =	3,428.4 lbs	R.M.=	9,312.2
Vertical Loads used for Soil Pressure =		3,428.4	lbs				

* Axial live load NOT included in total displayed, or used for overturning resistance, but is included for soil pressure calculation.

Vertical component of active lateral soil pressure IS NOT considered in the calculation of Sliding Resistance.

Vertical component of active lateral soil pressure IS NOT considered in the calculation of Overturning Resistance.

Tilt

Horizontal Deflection at Top of Wall due to settlement of soil

(Deflection due to wall bending not considered)

Soil Spring Reaction Modulus 250.0 pci
 Horizontal Defl @ Top of Wall (approximate only) 0.000 in

The above calculation is not valid if the heel soil bearing pressure exceeds that of the toe, because the wall would then tend to rotate into the retained soil.

This Wall in File:

Enercalc EARTH (c) 1987-2019, Build 11.19.06.12
License : KW-06011484
License To : CKS, KW-06011484

Cantilevered Retaining Wall

Code: IBC 2015,ACI 318-14,ACI 530-13

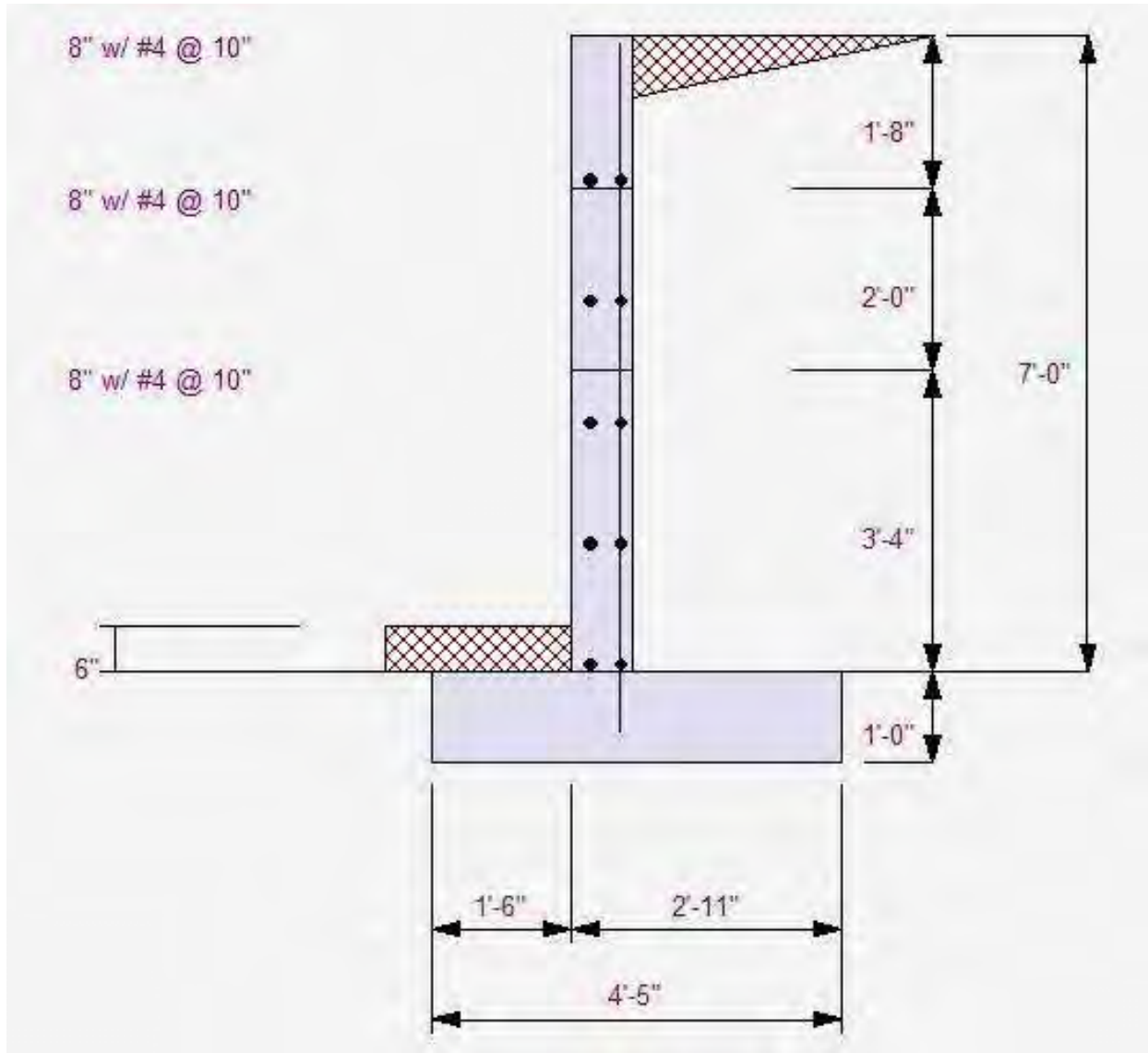

6'-0" MAX Catchment Wall (FOS=1.5)

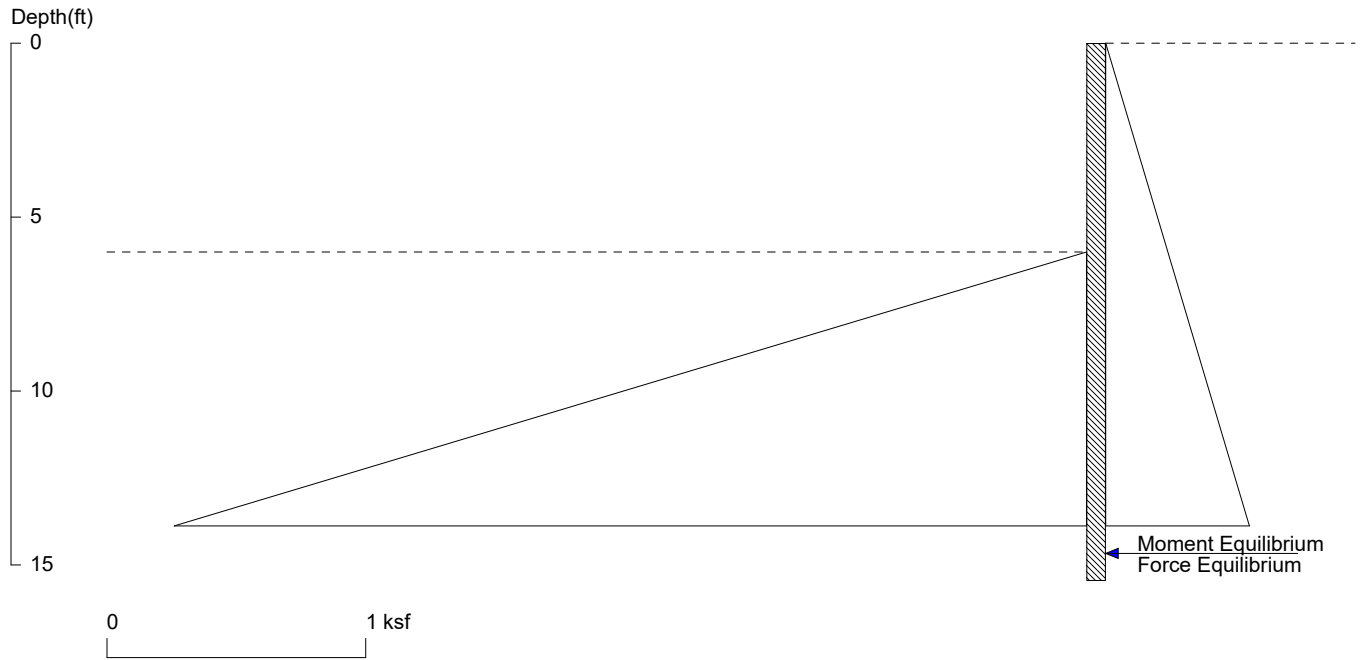

<ShoringSuite> CIVILTECH SOFTWARE USA www.civiltech.com

Licensed to 4324324234 3424343

Date: 3/11/2020

File: C:\Users\Chris\Desktop\6ft max catchment wall NO seismic.sh8

Wall Height=6.0

Pile Diameter=1.5

Pile Spacing=8.0

Wall Type: 2. Soldier Pile, Drilled

PILE LENGTH: Min. Embedment=9.45 Min. Pile Length=15.45

MOMENT IN PILE: Max. Moment=28.57 per Pile Spacing=8.0 at Depth=10.18

PILE SELECTION:

Request Min. Section Modulus = 10.4 in³/pile=170.26 cm³/pile, F_y= 50 ksi = 345 MPa, F_b/F_y=0.66

W8X15 has Section Modulus = 11.8 in³/pile=193.37 cm³/pile. It is greater than Min. Requirements!

Top Deflection = 0.79(in) based on E (ksi)=29000.00 and I (in⁴)/pile=48.0

DRIVING PRESSURES (ACTIVE, WATER, & SURCHARGE):

Z1	P1	Z2	P2	Slope
0	0	800	32.00	.04

PASSIVE PRESSURES: Pressures below will be divided by a Factor of Safety =1.5

Z1	P1	Z2	P2	Slope
6	0	800	355.5	0.4477

ACTIVE SPACING:

No.	Z depth	Spacing
1	0.00	8.00
2	6.00	1.50

PASSIVE SPACING:

No.	Z depth	Spacing
1	6.00	3.00

UNITS: Width, Spacing, Diameter, Length, and Depth - ft; Force - kip; Moment - kip-ft
Friction, Bearing, and Pressure - ksf; Pres. Slope - kip/ft³; Deflection - in

6'-0" MAX Catchment Wall (FOS=1.25) - Impact load

*GOVERNS
WORST CASE*

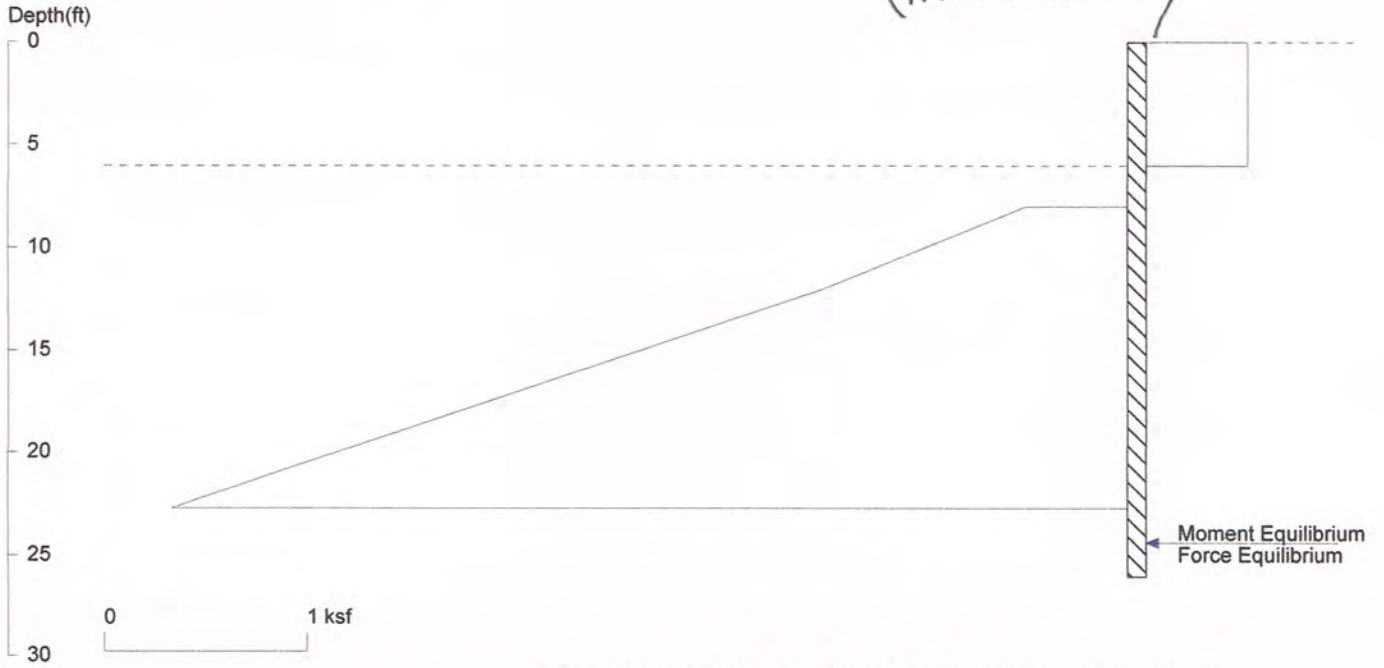

<ShoringSuite> CIVILTECH SOFTWARE USA www.civiltech.com

Licensed to 4324324234 3424343

Date: 6/19/2020

File: Z:_PROJECTS\2019\19-065 Yang Residence\2. Calculations\Shoring\6ft max catchment wall Impact load.sh8

Wall Height=6.0 Pile Diameter=1.5 Pile Spacing=8.0 Wall Type: 2. Soldier Pile, Drilled

PILE LENGTH: Min. Embedment=20.06 Min. Pile Length=26.06

MOMENT IN PILE: Max. Moment=223.77 per Pile Spacing=8.0 at Depth=15.06

PILE SELECTION:

Request Min. Section Modulus = 81.4 in³/pile=1333.43 cm³/pile, F_y= 50 ksi = 345 MPa, F_b/F_y=0.66
 W14X61 has Section Modulus = 92.1 in³/pile=1509.24 cm³/pile. It is greater than Min. Requirements!
 Top Deflection = 0.90(in) based on E (ksi)=29000.00 and I (in⁴)/pile=640.0

DRIVING PRESSURES (ACTIVE, WATER, & SURCHARGE):

Z1	P1	Z2	P2	Slope
0	.5	6	0.500	0.000000

PASSIVE PRESSURES: Pressures below will be divided by a Factor of Safety =1.25

Z1	P1	Z2	P2	Slope
8	.5	12	1.500	.25
12	1.5	800	237.900	.3

ACTIVE SPACING:

No.	Z depth	Spacing
1	0.00	8.00
2	6.00	1.50

PASSIVE SPACING:

No.	Z depth	Spacing
1	6.00	3.00

LAGGING DESIGN
l = 8' max
w = 0.5 (500 psf) = 250 lb/ft
f_b = 423 psf
f_v = 21 psf
Δ_{TL} = L/845
 P.T. 6x12 #2

UNITS: Width, Spacing, Diameter, Length, and Depth - ft; Force - kip; Moment - kip-ft
 Friction, Bearing, and Pressure - ksf; Pres. Slope - kip/ft³; Deflection - in